

Make
it
Wonderful

TOOTEKATALOOG 2021

TÄIUSLIK SÜSTEEMNE
KÖÖGITEHNIKA

Kehtib alates
2021.a.
versioon - 02.02.2021

FRANKE



UUS TOODETE VÄLJAPANEK JA KOOLITUSKESKUS BALTI RIIKIDES

Saate ülevaate Franke köögisüsteemide tooteportfelli.
Saate inspiratsiooni meie tooteseeriast.
Vaadake meie paremini müüdivaid mudeleid ja avastage uusi.
Osalege tootekoolitustel ja toiduvalmistamise töötubades.

FRANKE BALTIC
Marjās iela 13 k-2
Rīga, LV-1050, Latvija

TÄHELEPANU!

Hinnad on soovituslikud jaehinnad ja sisaldavad käibemaksu 20%.
Tootepildid on illustratiivsed, näiteks toode ei tarvitse sisaldada pildil toodud nõutuskaussi (jälgige alati tootekirjeldust!).
Valamul ja segistil võivad võrreldes tootenäidistega esineda tehnoloogias tulenevat värvierinevust. Tehniliste uuenduste tõttu võivad tooted erineda kataloogis toodud toodetest.
Franke ei võta endale vastutust kataloogis esinevate eksimuste, näiteks trükivigade eest. Kõigile toodetele kehtib garantii 2 aastat juhul, kui on järgitud paigaldus- ja kasutusjuhendit.

Garantiitööd, remont ja varuosad:
Eliser OÜ
Mustamäe tee 24,
Tallinn
teenindus@eliser.ee
tel: 6650090

INTERNET

Kõige värskema info saab alati leida www.franke.ee/ks

YOUTUBE

Vaata meid youtube kanalis
www.youtube.com/user/FrankeKitchenSystem

KATALOOG

Kataloogi ja muud materjale PDF formaadis saab alla laadida www.franke.ee/ks peatükkides [abi/brošüürid](#)

 www.facebook.com/FrankeKitchen.Baltic

SISUKORD

UUED TOOTED	4
ROOSTEVABAST TERASEST VALAMUD	6
MYTHOS (MYX)	10
ARGOS G (AGX)	12
BOX CENTER (BWX)	15
FRANKE BOX (BXX)	16
QUADRANT (QAX)	19
MARIS (MRX)	20
SPARK (SKX)	24
MIKADO (MOX)	26
RAPID (RPX)	27
SMART (SKX)	28
BELL (BCX)	29
PAMIRA (PMN, PML)	30
RONDA (ROX, RON, ROL) ja RAMBLA (RAX, RAN, RAL)	31
EUROFORM (EFX, EFN)	32
LOGICA LINE (LLX)	34
EUROSET (ESN)	35
KAPILE PAIGALDATAVAD VALAMUD (DSN)	35
EUROSTAR (ETN, ETL, ETX)	36
FRAGRANIT VALAMUD	38
FRESNO (FSG)	47
MYTHOS (MTG)	48
FX (FXG)	50
MARIS (MRG)	52
BASIS (BFG)	58
URBAN (UBG)	62
CENTRO (CNG)	66
RONDA (ROG)	70
STRATA (STG)	72
TECTONITE VALAMUD	74
SIRIUS	78
SINGLE	81
KERAAMILISED VALAMUD	82
MYTHOS (MTK)	86
SINGLE (SGK)	88
BELFAST (BAK)	89
ALTPOOLT MONTEERITAVAD VALAMUD	90
MYTHOS (MYX)	94
BOX (BXX)	96
MARIS (MRX)	98
ATON (ANX)	101
KUBUS 2 FRAGRANITE (KNG)	102
KUBUS FRAGRANITE (KBG)	104
KUBUS FRACERAM (KBK)	106
SEGISTID	108
VITAL	115
MONDIAL 4 in 1	117
ATLAS NEO SENSOR	119
WELLFRESH	121
ROOSTEVABAST TERASEST SEGISTID	122
KROOMIGA KAETUD JA VÄRVILISED SEGISTID	132
MUUDETAVA KÕRGUSEGA SEGISTID	149
SEEBIDOSAATORID	150
SORTERID	152
SORTER 60 CM	154
SORTER 50 ja 45 CM	156
SORTER 40 CM	157
SORTER 30 CM ja NURK	158
SORTERITE LISAD	159
JÄÄTMEPURUSTAJAD	161
LISAD	162
RULLMATID	162
MOBIILSED NÕRUTID	164
LÕIKELAUAD	166
NÕRUTUSKAUSID	168
VALAMUTE JA SEGISTITE LISAD	170
ARTIKLINUMBRITE REGISTER	176
SÜMBOLITE SELETUS	179

UUDISED 2021

MYTHOS



MYX 211 A  
860 x 520 mm 10. lk.



MYX 210-70  
712 x 412 mm 11. lk.



MYX 210-45  
462 x 412 mm 11. lk.

MYX 110-45 
490 x 440 mm 95. lk.

BELL



BCX 610-51 
510 x 510 mm 29. lk.

CENTRO



CNG 611-86  
860 x 500 mm 66. lk.





CNG 611-78  
780 x 500 mm 67. lk.





CNG 611-62  
620 x 500 mm 67. lk.



CNG 610-54  
590 x 500 mm 68. lk.



CNG 610-39  
440 x 500 mm 69. lk.

Lisaks on järgmised värviliste valamute sarjad saadaval mattvärvides



Fresno
FSG 611-88 
877 x 495 mm 47. lk.



Kubus 2
KNG 110-62
760 x 460 mm 102. lk.



Kubus 2
KNG 110-52
560 x 460 mm 103. lk.



Kubus 2
KNG 110-37
410 x 460 mm 103. lk.



ATLAS NEO SENSOR 119. lk.



TAROS NEO 129. lk.



LIFT 135. lk.



ICON 134. lk.



TANGO NEO 124. lk.



CENTRO 141. lk.



ORBIT 140. lk.



LINA L 145. lk.



LINA SEMI PRO 144. lk.



LINA 145. lk.



LINA XL 144. lk.



TAROS NEO WINDOW 149. lk.



0,75 Hp
JÄÄTMEPURUSTAJA 161. lk.
0,5 Hp

ROOSTEVABAST TERASEST VALAMUD



- ① Plastikust raamiga mobiilne nõruti teeb valamu suuremaks.



- ② Nurgaraadius 25 mm vertikaalsetel seintel ja 10 mm põhjas muudab valamu visuaalselt täisnurkseks ja ühtlasi on seda lihtne puhastada.



- ③ Kattega ülevoolu on lihtne puhastada ja sellel on diskreetne väljanägemine



- ④ Katteplaadiga kaetud äravool võimaldab hoida püsivat puhas ilmet isegi üldpuhastuse vaheaegade ajal.



- ⑤ SlimTop ja tasapinnaline paigaldus võimaldavad tööpinna ja kausi vahel sujuvat ilma piirideta üleminekut



- ⑥ Vajutusnappu on lihtne vajutada isegi küünarnukiga ja see näeb tööpinna täiuslik välja



- ⑦ Erinevad tarvikud, näiteks rullimatt, võimaldavad teil samas kausis rohkem teha.



Roostevabast terasest valamud aluskapi laiuse järgi

60 cm



Spark
SKX 651
1000 x 500 mm
24. lk.



Euroform
EFN 651-78
780 x 475 mm
32. lk.



Mikado
MOX 260
575 x 505 mm
26. lk.



Mythos
MYX 211 A **UUDIS**
860 x 520 mm
10. lk.



Argos
AGX 211-100
1000 x 510 mm
12. lk.



Rapid
RPX 611-86XL
860 x 500 mm
27. lk.



Smart
SRX 611-86XL
860 x 500 mm
28. lk.



Maris
MRX 210-50TL
530 x 510 mm
21. lk.



Mythos
MYX 210-50
512 x 412 mm
11. lk.



Franke Box
BXX 210/110-54
580 x 450 mm
17. lk.



Franke Box
BXX 210/110-50
540 x 450 mm
17. lk.



Maris
MRX 210-50
540 x 440 mm
23. lk.

50 cm



Euroform
EFX 614-78
EFN 614-78
780 x 475 mm
33. lk.



Maris
MRX 210-40TL
430 x 510 mm
23. lk.



Bell
BCX 610-51 **UUDIS**
510 x 510 mm
29. lk.



Mythos
MYX 210-45 **UUDIS**
462 x 412 mm
11. lk.



Franke Box
BXX 210/110-45
490 x 450 mm
17. lk.



Maris
MRX 210-45
490 x 440 mm
23. lk.



Maris
MRX 210-40
440 x 440 mm
23. lk.



Quadrant
QAX 210
445 x 415 mm
19. lk.

45 cm



Argos
AGX 211-78
780 x 510 mm
13. lk.



Argos
AGX 211-62
625 x 510 mm
13. lk.



Spark
SKX 611-86
860 x 500 mm
25. lk.



Spark
SKX 611-79
790 x 500 mm
25. lk.



Spark
SKX 611-63
SKN 611-63
625 x 500 mm
25. lk.



Smart
SRX 611-86
860 x 500 mm
28. lk.



Logica Line
LLX 611
790 x 500 mm
34. lk.



Rapid
RPX 211
864 x 514 mm
27. lk.



Eurostar
ETN 614 Nova
ETL 614 Nova
780 x 435 mm
36. lk.



Euroset
ESN 614
860 x 435 mm
35. lk.



Franke Box
BXX 210/110-40
440 x 450 mm
18. lk.



Eurostar
ETN 610
455 x 435 mm
37. lk.



Pamira
PMN 611
PML 611
770 x 500 mm
30. lk.



Ronda
ROX 610-41
RON 610-41
ROL 610-41
Ø 510 mm
31. lk.



Rambla
RAX 610-38
RAN 610-38
RAL 610-38
Ø 430 mm
31. lk.

40 cm



Franke Box
BXX 210/110-34
440 x 450 mm
18. lk.



Maris
MRX 210-34
380 x 440 mm
23. lk.



Eurostar
ETN 611-58
ETL 611-58
580 x 510 mm
37. lk.

80 cm



Mythos
MYX 210-70 **UUDIS**
712 x 412 mm
11. lk.



Franke Box
BXX 210/110-68
725 x 45 mm
16. lk.



Maris
MRX 210-70
740 x 440 mm
22. lk.



Maris
MRX 210-70TL
730 x 510 mm
20. lk.



Euroform
EFX 620-78
780 x 475 mm
33. lk.

90 cm



Box Center
BWX 220-54-27 A
860 x 510 mm
15. lk.

Nurgavalamud



Spark
SKX 651-E
960 x 500 mm
26. lk.

KAPILE PAIGALDATAVAD VALAMUD



DSN 711
800 x 600 mm
35. lk.





MYTHOS roostevabast terasest valamud

Lisad

- | | | | |
|---|---|---|---|
| <p>1 112.0599.107</p> <p>Nõrutuskauss, rv teras plastik raam
180 x 412 x 60 mm
€ 98,40</p>  | <p>2 112.0591.082</p> <p>Lõikelaud Stonepaper Slate
180 x 412 mm
€ 94,60</p>  | <p>3 112.0591.081</p> <p>Rullmatt painduv
252 x 424 mm
€ 54,00</p>  | <p>4 112.0602.288</p> <p>Rv Mobiilne nõruti plastik raamis
298 x 412 mm
€ 84,90</p>  |
|---|---|---|---|



Mudel **MYX 211 A**
 Aluskapp 60 cm
 Mõõdud 860 x 520 mm
 Väljalõige SlimTop jaoks 846 x 506 mm
 Kausi mõõtmed 500 / 400 / 180 mm
 Kausi asukoht Vasak või parem pool
 Paigaldamine Slim Top või tasapinnaline
 Materjal Roostevaba teras
 Ventiiil Integreeritud ventiiil
 Ventiiili juhtimine Vajutusnupp ümmargune roostevaba teras
 Ülevool Katteplaadiga ülevool
 Segisti augud Segisti ja nupu jaoks 2x 35 mm auk
 Tööpind min paksus 12 mm

Kausi asukoht	Artikkel	Hind €
 Kauss paremal	127.0637.415	662,00
 Kauss vasakul	127.0637.416	662,00

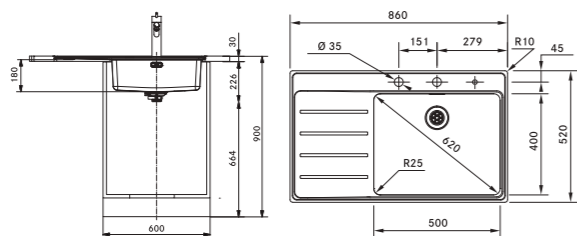

Mudel **MYX 210-70**
 Aluskapp 80 cm
 Mõõdud 712 x 412 mm
 Väljalõige SlimTop jaoks 706 x 406 mm (R = 28 mm)
 Kausi mõõtmed 700 / 400 / 200 mm
 Paigaldamine Slim Top või tasapinnaline
 Materjal Roostevaba teras poleeritud
 Ventiiil Integreeritud ventiiil
 Ventiiili juhtimine Vajutusnupp ümmargune roostevaba teras (tööpinnale on vaja 35 mm auk)
 Ülevool Katteplaadiga ülevool
 Tööpind min paksus 12 mm

Komplekt	Artikkel	Hind €
Valamu ventiiliga	127.0603.546	707,00

UUDIS

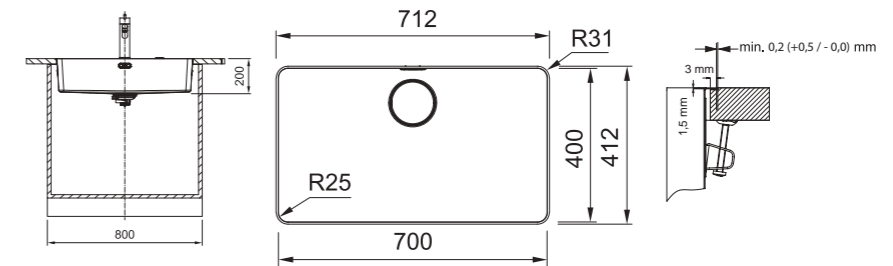

Mudel **MYX 210-50**
 Aluskapp 60 cm
 Mõõdud 512 x 412 mm
 Väljalõige SlimTop jaoks 506 x 406 mm (R = 28 mm)
 Kausi mõõtmed 500 / 400 / 200 mm
 Paigaldamine Slim Top või tasapinnaline
 Materjal Roostevaba teras poleeritud
 Ventiiil Integreeritud ventiiil
 Ventiiili juhtimine Vajutusnupp ümmargune roostevaba teras (tööpinnale on vaja 35 mm auk)
 Ülevool Katteplaadiga ülevool
 Tööpind min paksus 12 mm

Komplekt	Artikkel	Hind €
Valamu ventiiliga	127.0603.544	610,00

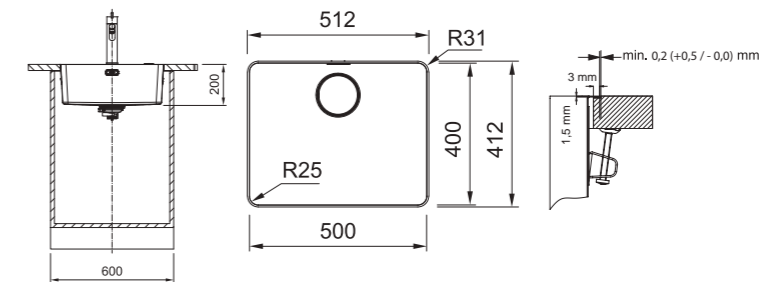

Mudel **MYX 210-45**
 Aluskapp 50 cm
 Mõõdud 462 x 412 mm
 Väljalõige SlimTop jaoks 456 x 406 mm (R = 28 mm)
 Kausi mõõtmed 450 / 400 / 200 mm
 Paigaldamine Slim Top või tasapinnaline
 Materjal Roostevaba teras poleeritud
 Ventiiil Integreeritud ventiiil
 Ventiiili juhtimine Vajutusnupp ümmargune roostevaba teras (tööpinnale on vaja 35 mm auk)
 Ülevool Katteplaadiga ülevool
 Tööpind min paksus 12 mm

Komplekt	Artikkel	Hind €
Valamu ventiiliga	127.0603.543	587,00

UUDIS

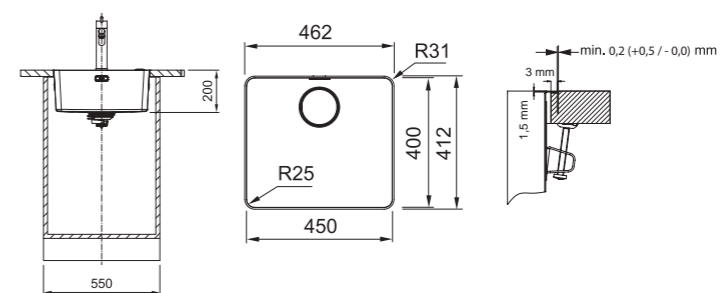

Järgmiste mudelite jaoks tuleks enne paigaldamist teha tööpinna väljalõige ülevoolu jaoks:
 MYX 210-70, MYX 210-50, MYX 210-45

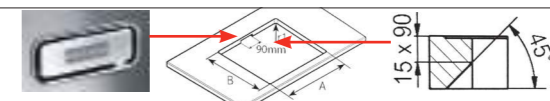



ARGOS roostevabast terasest valamud

Lisad

1 112.0035.622
Lõikelaud puit
362 x 447 mm
€ 60,70



2 112.0281.982
Rullmatt painduv
400 x 458 mm
€ 77,40



Mudel **AGX 211-100**
Aluskapp 60 cm
Mõõdud 1000 x 510 mm
Väljalõige SlimTop jaoks 987 x 497 mm (R= 10 mm)
Kausi mõõtmed 435 /435 /180 mm
Kausi asukoht Pööratav
Paigaldamine Slim Top või tasapinnaline
Materjal Roostevaba teras
Ventiiil Integreeritud ventiiil
Ventiiili juhtimine Vajutusnupp ümmargune roostevaba teras
Ülevool Katteplaadiga ülevool
Segisti augud Segisti ja nupu jaoks 2x 35 mm auk
Tööpind min 30 mm paksune

Komplekt	Artikkel	Hind €
Valamu ventiiiliga	127.0380.396	428,00

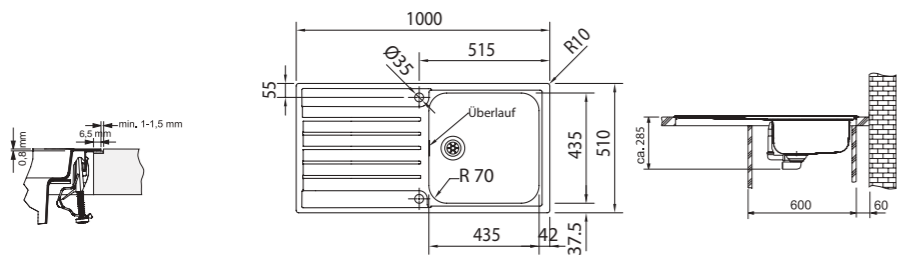

Mudel **AGX 211-78**
Aluskapp 45 cm
Mõõdud 780 x 510 mm
Väljalõige SlimTop jaoks 767 x 497 mm (R= 10 mm)
Kausi mõõtmed 350 /435 /175 mm
Kausi asukoht Pööratav
Paigaldamine Slim Top või tasapinnaline
Materjal Roostevaba teras
Ventiiil Integreeritud ventiiil
Ventiiili juhtimine Vajutusnupp ümmargune roostevaba teras
Ülevool Katteplaadiga ülevool
Segisti augud Segisti ja nupu jaoks 2x 35 mm auk
Tööpind min 30 mm paksune

Komplekt	Artikkel	Hind €
Valamu ventiiiliga	127.0476.541	376,00

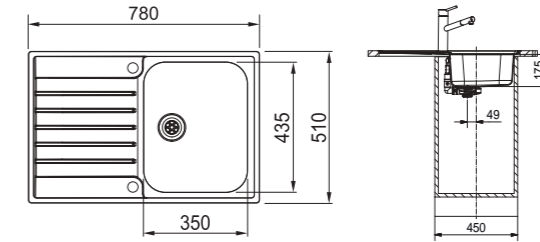
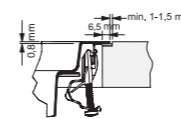

Mudel **AGX 211-62**
Aluskapp 45 cm
Mõõdud 625 x 510 mm
Väljalõige SlimTop jaoks 612 x 497 mm (R= 10 mm)
Kausi mõõtmed 350 /435 /175 mm
Kausi asukoht Pööratav
Paigaldamine Slim Top või tasapinnaline
Materjal Roostevaba teras
Ventiiil Integreeritud ventiiil
Ventiiili juhtimine Vajutusnupp ümmargune roostevaba teras
Ülevool Katteplaadiga ülevool
Segisti augud Segisti ja nupu jaoks 2x 35 mm auk
Tööpind min 30 mm paksune

Komplekt	Artikkel	Hind €
Valamu ventiiiliga	127.0476.450	321,00

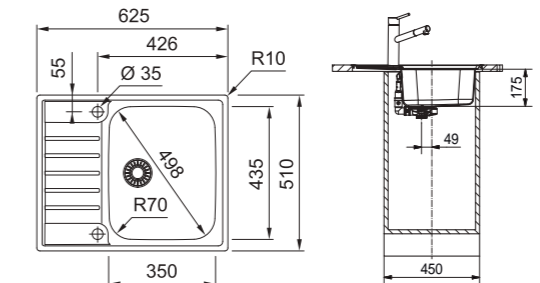
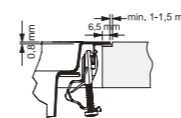

7.00 HOMMIKUL

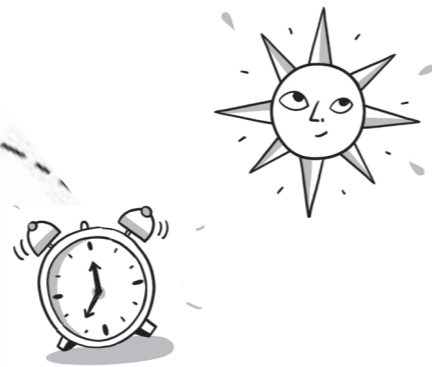

12:30 ON LÕUNAAEG



KELL 20.00 HEAD ISU!



23:00 HEAD ÖÖD!



BOX CENTER funktsionaalne roostevabast terasest valamu, millel on lai valik tarvikuid

Lisatarvikud, mis kuuluvad komplekti



Lisad

1 112.0204.360

Rv Mobiilne nõruti plastik raamis
326 x 440 x 23 mm
€ 101,90



Mudel **BWX 220-54-27 A**
Aluskapp **90 cm**
Möödud **860 x 510 mm**
Väljalõige SlimTop jaoks **840 x 490 mm (R = 10 mm)**
Kausi mõõtmed **540 / 410 / 200 + 270 / 480 / 200 mm**
Kausi asukoht Vasak või parem pool
Paigaldamine **Slim Top või tasapinnaline**
Materjal **Roostevaba teras**
Ventil **Integreeritud ja 3/2" ventiil**
Ventili juhtimine **Vajutusnupp ümmargune roostevaba teras**
Ülevool **Katteplaadiga ülevool**
Segisti augud **Segisti ja nupu jaoks 2x 35 mm auk**
Tööpind **min paksus 12 mm**

Kausi asukoht	Artikkel	Hind €
Suur kaus paremal	127.0558.824	1304,00
Suur kaus vasakul	127.0558.826	1304,00

SISALDUB KOMPLEKTIS



Lisad

1

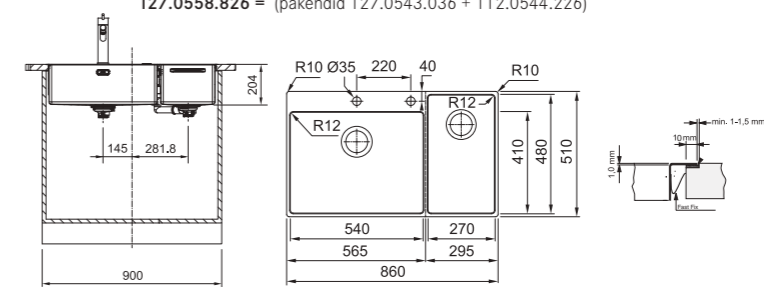



BOX roostevabast terasest valamud

Lisad

- | | | | |
|--|---|--|---|
| <p>1 112.0539.120</p> <p>Lõikelaud-plastik
429 x 180 mm
€ 47,80</p>  | <p>2 112.0080.355</p> <p>Rullmatt painduv
468 x 440 mm
€ 72,10</p>  | <p>3 112.0204.360</p> <p>Rv Mobiilne nõruti plastik raamis
326 x 440 x 23 mm
€ 101,90</p>  | <p>4 112.0394.981</p> <p>Roostevabast terasest nõrutus-
kauss plastkäepidemetega
429 x 156 mm
€ 91,50</p>  |
|--|---|--|---|



Mudel **BXX 210/110-68**
 Aluskapp **80 cm**
 Mõõdud **725 x 450 mm**
 Väljalõige SlimTop jaoks **695 x 420 mm (R = 10 mm)**
 Kausi mõõtmed **685 / 410 / 200 mm**
 Paigaldamine **SlimTop, tasapinnaline või altpoolt**
 Materjal **Roostevaba teras**
 Ventiiil **Integreeritud või 3 1/2" ventiiil**
 Ventiiili juhtimine **Vajutusnupp ümmargune roostevaba teras või käsitsi**
 Vajutusnupu auk **35mm**
 Ülevool **Katteplaadiga ülevool**
 Tööpind **min paksus 12 mm**

Komplekt Artikkel Hind €

Valamu ventiiliga 127.0539.907 434,00



Valamu ventiiliga 127.0539.906 393,00

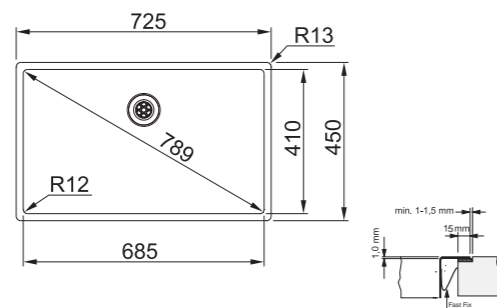

Mudel **BXX 210/110-54**
 Aluskapp **60 cm**
 Altpoolt monteeritavm skapim **80 cm**
 Mõõdud **580 x 450 mm**
 Väljalõige SlimTop jaoks **550 x 420 mm (R = 10 mm)**
 Kausi mõõtmed **540 / 410 / 200 mm**
 Paigaldamine **SlimTop, tasapinnaline või altpoolt**
 Materjal **Roostevaba teras**
 Ventiiil **Integreeritud või 3 1/2" ventiiil**
 Ventiiili juhtimine **Vajutusnupp ümmargune roostevaba teras või käsitsi**
 Vajutusnupu auk **35mm**
 Ülevool **Katteplaadiga ülevool**
 Tööpind **min paksus 12 mm**

Komplekt Artikkel Hind €

Valamu ventiiliga 127.0375.278 383,00



Valamu ventiiliga 127.0372.488 338,00

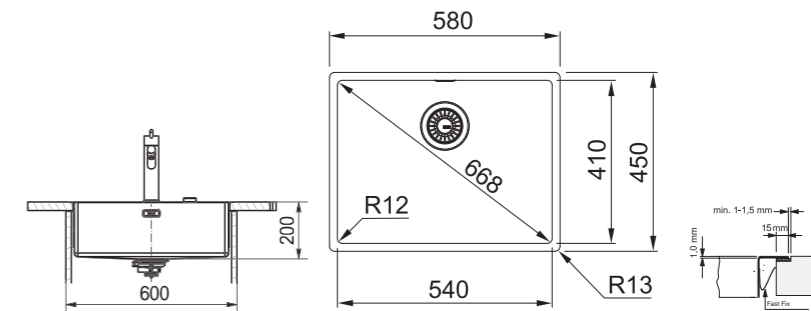
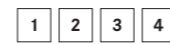

Mudel **BXX 210/110-50**
 Aluskapp **60 cm**
 Mõõdud **540 x 450 mm**
 Väljalõige SlimTop jaoks **510 x 420 mm (R = 10 mm)**
 Kausi mõõtmed **500 / 410 / 200 mm**
 Paigaldamine **SlimTop, tasapinnaline või altpoolt**
 Materjal **Roostevaba teras**
 Ventiiil **Integreeritud või 3 1/2" ventiiil**
 Ventiiili juhtimine **Vajutusnupp ümmargune roostevaba teras või käsitsi**
 Vajutusnupu auk **35mm**
 Ülevool **Katteplaadiga ülevool**
 Tööpind **min paksus 12 mm**

Komplekt Artikkel Hind €

Valamu ventiiliga 127.0375.273 374,00



Valamu ventiiliga 127.0374.206 329,00

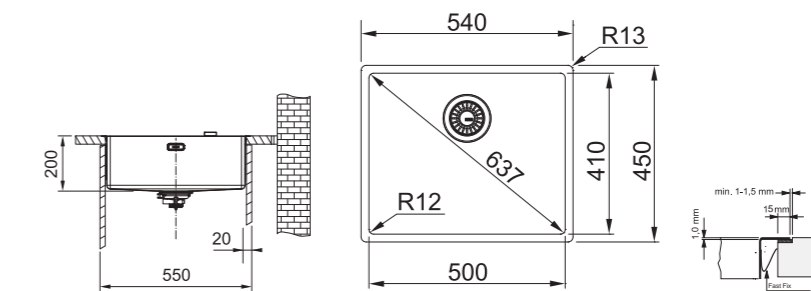
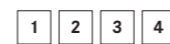

Mudel **BXX 210/110-45**
 Aluskapp **50 cm**
 Altpoolt monteeritavm skapim **60 cm**
 Mõõdud **490 x 450 mm**
 Väljalõige SlimTop jaoks **460 x 420 mm (R = 10 mm)**
 Kausi mõõtmed **450 / 410 / 200 mm**
 Paigaldamine **SlimTop, tasapinnaline või altpoolt**
 Materjal **Roostevaba teras**
 Ventiiil **Integreeritud või 3 1/2" ventiiil**
 Ventiiili juhtimine **Vajutusnupp ümmargune roostevaba teras või käsitsi**
 Vajutusnupu auk **35mm**
 Ülevool **Katteplaadiga ülevool**
 Tööpind **min paksus 12 mm**

Komplekt Artikkel Hind €

Valamu ventiiliga 127.0375.257 360,00



Valamu ventiiliga 127.0372.489 315,00

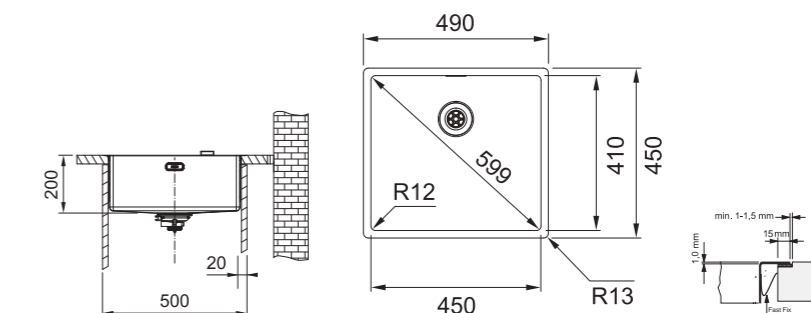

BOX roostevabast terasest valamud

Lisad

- | | | | |
|--|---|--|---|
| <p>1 112.0539.120</p> <p>Lõikelaud-plastik
429 x 180 mm
€ 47,80</p>  | <p>2 112.0080.355</p> <p>Rullmatt painduv
468 x 440 mm
€ 72,10</p>  | <p>3 112.0204.360</p> <p>Rv Mobiilne nõruti plastik raamis
326 x 440 x 23 mm
€ 101,90</p>  | <p>4 112.0394.981</p> <p>Roostevabast terasest nõrutus-
kauss plastkäepidemetega
429 x 156 mm
€ 91,50</p>  |
|--|---|--|---|



<p>Mudel BXX 210/110-40</p> <p>Aluskapp 45 cm</p> <p>Altpoolt monteeritavm skapim 50 cm</p> <p>Mõõdud 440 x 450 mm</p> <p>Väljalõige SlimTop jaoks 410 x 420 mm (R = 10 mm)</p> <p>Kausi mõõtmed 400 / 410 / 200 mm</p> <p>Paigaldamine SlimTop, tasapinnaline või altpoolt</p> <p>Materjal Roostevaba teras</p> <p>Ventii Integreeritud või 3½" ventii</p> <p>Ventii juhtimine Vajutusnupp ümmargune roostevaba teras või käsitsi</p> <p>Vajutusnupu auk 35mm</p> <p>Ülevool Katteplaadiga ülevool</p> <p>Tööpind min paksus 12 mm</p>	<table border="0"> <tr> <th>Komplekt</th> <th>Artikkel</th> <th>Hind €</th> </tr> <tr> <td>Valamu ventiiuga</td> <td>127.0375.252</td> <td>351,00</td> </tr> <tr> <td>Valamu ventiiuga</td> <td>127.0375.284</td> <td>306,00</td> </tr> </table>	Komplekt	Artikkel	Hind €	Valamu ventiiuga	127.0375.252	351,00	Valamu ventiiuga	127.0375.284	306,00
Komplekt	Artikkel	Hind €								
Valamu ventiiuga	127.0375.252	351,00								
Valamu ventiiuga	127.0375.284	306,00								

- 1 2 3 4

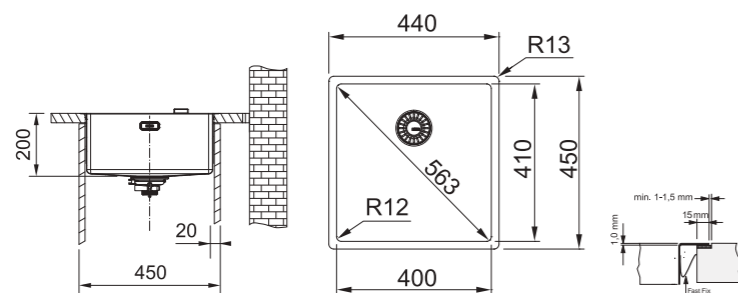

<p>Mudel BXX 210/110-34</p> <p>Aluskapp 40 cm</p> <p>Altpoolt monteeritavm skapim 45 cm</p> <p>Mõõdud 380 x 450 mm</p> <p>Väljalõige SlimTop jaoks 350 x 420 mm (R = 10 mm)</p> <p>Kausi mõõtmed 340 / 410 / 200 mm</p> <p>Paigaldamine SlimTop, tasapinnaline või altpoolt</p> <p>Materjal Roostevaba teras</p> <p>Ventii Integreeritud või 3½" ventii</p> <p>Ventii juhtimine Vajutusnupp ümmargune roostevaba teras või käsitsi</p> <p>Vajutusnupu auk 35mm</p> <p>Ülevool Katteplaadiga ülevool</p> <p>Tööpind min paksus 12 mm</p>	<table border="0"> <tr> <th>Komplekt</th> <th>Artikkel</th> <th>Hind €</th> </tr> <tr> <td>Valamu ventiiuga</td> <td>127.0374.687</td> <td>333,00</td> </tr> <tr> <td>Valamu ventiiuga</td> <td>127.0372.501</td> <td>292,00</td> </tr> </table>	Komplekt	Artikkel	Hind €	Valamu ventiiuga	127.0374.687	333,00	Valamu ventiiuga	127.0372.501	292,00
Komplekt	Artikkel	Hind €								
Valamu ventiiuga	127.0374.687	333,00								
Valamu ventiiuga	127.0372.501	292,00								

- 1 2 3 4

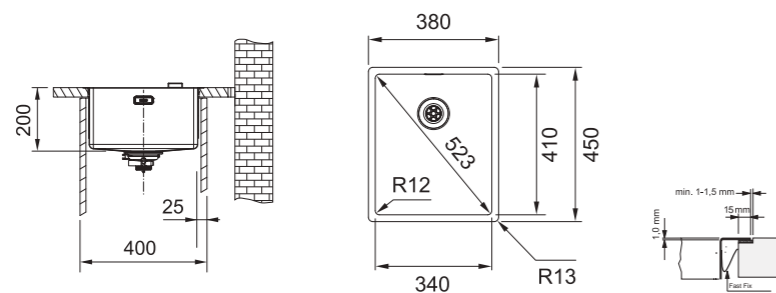

Järgmiste mudelite jaoks tuleks enne paigaldamist teha tööpinna väljalõige ülevoolu jaoks:

- BXX 210/110-54,
BXX 210/110-50,
BXX 210/110-45,
BXX 210/110-40,
BXX 210/110-34

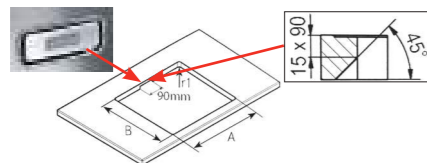

QUADRANT roostevabast terasest valamud



<p>Mudel QAX 210</p> <p>Aluskapp 50 cm</p> <p>Mõõdud 445 x 415 mm</p> <p>Väljalõige SlimTop jaoks Šablooni järgi</p> <p>Kausi mõõtmed 400 / 370 / 160 mm</p> <p>Paigaldamine Slim Top või tasapinnaline</p> <p>Materjal Roostevaba teras poleeritud</p> <p>Ventii Nupuga avatav 3½" ventii</p> <p>Ventii juhtimine Keeratav nupp</p> <p>Vajutusnupu auk 35mm</p> <p>Tööpind min 30 mm paksune</p> <p>Jäätmepurustaja Ühilduv</p>	<table border="0"> <tr> <th>Komplekt</th> <th>Artikkel</th> <th>Hind €</th> </tr> <tr> <td>Valamu ventiiuga</td> <td>127.0044.474</td> <td>195,00</td> </tr> </table>	Komplekt	Artikkel	Hind €	Valamu ventiiuga	127.0044.474	195,00
Komplekt	Artikkel	Hind €					
Valamu ventiiuga	127.0044.474	195,00					

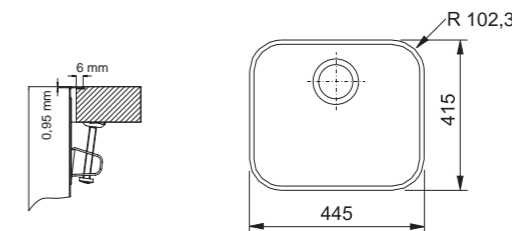



MARIS roostevabast terasest valamud

Lisad

<p>1 112.0520.497</p> <p>Nõrutuskauss, rv teras plastik raam 181 x 431 mm € 48,30</p> 	<p>2 112.0520.471</p> <p>Lõikelaud-plastik 200 x 510 x 16 mm € 38,60</p> 	<p>3 112.0080.355</p> <p>Rullmatt paindub 468 x 440 mm € 72,10</p> 	<p>4 112.0188.651</p> <p>Rv Mobiilne nõruti plastik raamis 342 x 430 x 22 mm € 93,70</p> 
---	--	--	---

<p>5 112.0057.850</p> <p>Nõrutuskauss- roostevaba teras 412 x 172 mm € 38,60</p> 	<p>6 112.0530.071</p> <p>Lõikelaud-plastik 200 x 440 x 16 mm € 38,60</p> 
---	---



	<p>Mudel MRX 210-70 TL</p> <p>Aluskapp 80 cm</p> <p>Mõõdud 730 x 510 mm</p> <p>Väljalõige SlimTop jaoks 710 x 490 mm (R = 10 mm)</p> <p>Kausi mõõtmed 700 / 400 / 180 mm</p> <p>Paigaldamine Slim Top või tasapinnaline</p> <p>Materjal Roostevabast teras harjatud</p> <p>Ventiil Manuaalne 3½" ventiil</p> <p>Ventiili juhtimine Käsitsi avamine / sulgemine</p> <p>Ülevool Katteplaadiga ülevool</p> <p>Segisti augud Segisti jaoks 35 mm auk</p> <p>Tööpind min paksus 12 mm</p> <p>Kinnitussüsteem FastFix süsteem</p> <p>Jäätmepurustaja Ühilduv</p>		<p>Komplekt</p> <p>Valamu ventiiliga</p> <p>Artikkel 127.0531.917</p> <p>Hind € 398,00</p>
--	--	--	--



Tasapinnalise paigalduse süvend

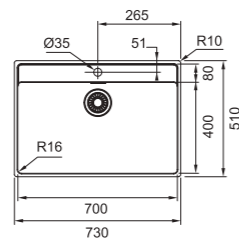
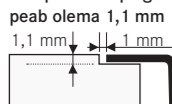

	<p>Mudel MRX 210-50 TL</p> <p>Aluskapp 60 cm</p> <p>Mõõdud 530 x 510 mm</p> <p>Väljalõige SlimTop jaoks 510 x 490 mm (R = 10 mm)</p> <p>Kausi mõõtmed 500 / 400 / 180 mm</p> <p>Paigaldamine Slim Top või tasapinnaline</p> <p>Materjal Roostevabast teras harjatud</p> <p>Ventiil Manuaalne 3½" ventiil</p> <p>Ventiili juhtimine Käsitsi avamine / sulgemine</p> <p>Ülevool Katteplaadiga ülevool</p> <p>Segisti augud Segisti jaoks 35 mm auk</p> <p>Tööpind min paksus 12 mm</p> <p>Kinnitussüsteem FastFix süsteem</p> <p>Jäätmepurustaja Ühilduv</p>		<p>Komplekt</p> <p>Valamu ventiiliga</p> <p>Artikkel 127.0531.852</p> <p>Hind € 293,00</p>
--	--	--	--

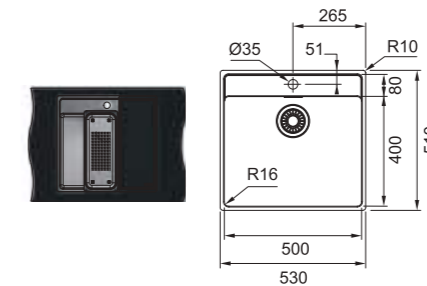

	<p>Mudel MRX 210-40 TL</p> <p>Aluskapp 50 cm</p> <p>Mõõdud 430 x 510 mm</p> <p>Väljalõige SlimTop jaoks 410 x 490 mm (R = 10 mm)</p> <p>Kausi mõõtmed 400 / 400 / 180 mm</p> <p>Paigaldamine Slim Top või tasapinnaline</p> <p>Materjal Roostevabast teras harjatud</p> <p>Ventiil Manuaalne 3½" ventiil</p> <p>Ventiili juhtimine Käsitsi avamine / sulgemine</p> <p>Ülevool Katteplaadiga ülevool</p> <p>Segisti augud Segisti jaoks 35 mm auk</p> <p>Tööpind min paksus 12 mm</p> <p>Kinnitussüsteem FastFix süsteem</p> <p>Jäätmepurustaja Ühilduv</p>		<p>Komplekt</p> <p>Valamu ventiiliga</p> <p>Artikkel 127.0531.851</p> <p>Hind € 272,00</p>
--	--	--	--



Tasapinnalise paigalduse süvend

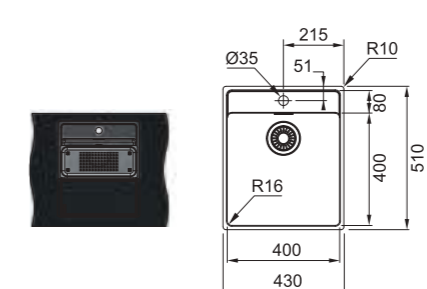
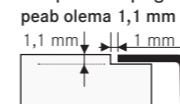



MARIS roostevabast terasest valamud

Lisad

- | | | | |
|---|---|---|--|
| <p>1 112.0057.850</p> <p>Nõrutuskauss- roostevaba teras
412 x 172 mm
€ 38,60</p>  | <p>2 112.0530.071</p> <p>Lõikelaud-plastik
200 x 440 x 16 mm
€ 38,60</p>  | <p>3 112.0030.882</p> <p>Rullmatt paindub
468 x 420 mm
€ 69,00</p>  | <p>4 112.0188.651</p> <p>Rv Mobiilne nõruti plastik raamis
342 x 430 x 22 mm
€ 93,70</p>  |
|---|---|---|--|



<p>Mudel MRX 210-70 Aluskapp 80 cm Mõõdud 740 x 440 mm Väljalõige SlimTop jaoks 710 x 410 mm (R = 10 mm) Kausi mõõtmed 700 / 400 / 180 mm Paigaldamine Slim Top või tasapinnaline Materjal Roostevabast teras harjatud Ventil Manuaalne 3½" ventiil Ventili juhtimine Käsitsi avamine / sulgemine Ülevool Katteplaadiga ülevool Tööpind min paksus 12 mm Kinnitussüsteem FastFix süsteem Jäätmepurustaja Ühilduv</p>	<p>Komplekt</p> <p>Valamu ventiiliga</p>	<p>Artikkel</p> <p>127.0531.916</p>	<p>Hind €</p> <p>365,00</p>
---	--	---	------------------------------------



Tasapinnalise paigalduse süvend peab olema 1,1 mm

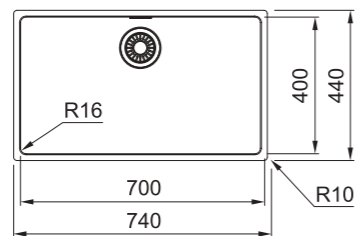
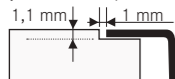

<p>Mudel MRX 210-50 Aluskapp 60 cm Mõõdud 540 x 440 mm Väljalõige SlimTop jaoks 510 x 410 mm (R = 10 mm) Kausi mõõtmed 500 / 400 / 180 mm Paigaldamine Slim Top või tasapinnaline Materjal Roostevabast teras harjatud Ventil Manuaalne 3½" ventiil Ventili juhtimine Käsitsi avamine / sulgemine Ülevool Katteplaadiga ülevool Tööpind min paksus 12 mm Kinnitussüsteem FastFix süsteem Jäätmepurustaja Ühilduv</p>	<p>Komplekt</p> <p>Valamu ventiiliga</p>	<p>Artikkel</p> <p>127.0531.810</p>	<p>Hind €</p> <p>272,00</p>
---	--	---	------------------------------------

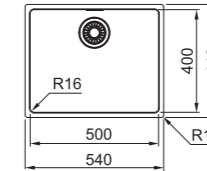

<p>Mudel MRX 210-45 Aluskapp 50 cm Mõõdud 490 x 440 mm Väljalõige SlimTop jaoks 460 x 410 mm (R = 10 mm) Kausi mõõtmed 450 / 400 / 180 mm Paigaldamine Slim Top või tasapinnaline Materjal Roostevabast teras harjatud Ventil Manuaalne 3½" ventiil Ventili juhtimine Käsitsi avamine / sulgemine Ülevool Katteplaadiga ülevool Tööpind min paksus 12 mm Kinnitussüsteem FastFix süsteem Jäätmepurustaja Ühilduv</p>	<p>Komplekt</p> <p>Valamu ventiiliga</p>	<p>Artikkel</p> <p>127.0553.961</p>	<p>Hind €</p> <p>262,00</p>
---	--	---	------------------------------------

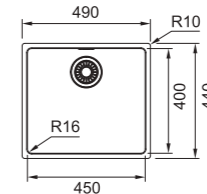

<p>Mudel MRX 210-40 Aluskapp 50 cm Mõõdud 440 x 440 mm Väljalõige SlimTop jaoks 410 x 410 mm (R = 10 mm) Kausi mõõtmed 400 / 400 / 180 mm Paigaldamine Slim Top või tasapinnaline Materjal Roostevabast teras harjatud Ventil Manuaalne 3½" ventiil Ventili juhtimine Käsitsi avamine / sulgemine Ülevool Katteplaadiga ülevool Tööpind min paksus 12 mm Kinnitussüsteem FastFix süsteem Jäätmepurustaja Ühilduv</p>	<p>Komplekt</p> <p>Valamu ventiiliga</p>	<p>Artikkel</p> <p>127.0531.809</p>	<p>Hind €</p> <p>251,00</p>
---	--	---	------------------------------------

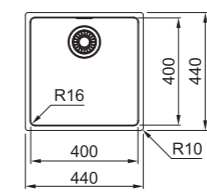

<p>Mudel MRX 210-34 Aluskapp 40 cm Mõõdud 380 x 440 mm Väljalõige SlimTop jaoks 350 x 410 mm (R = 10 mm) Kausi mõõtmed 340 / 400 / 180 mm Paigaldamine Slim Top või tasapinnaline Materjal Roostevabast teras harjatud Ventil Manuaalne 3½" ventiil Ventili juhtimine Käsitsi avamine / sulgemine Ülevool Katteplaadiga ülevool Tööpind min paksus 12 mm Kinnitussüsteem FastFix süsteem Jäätmepurustaja Ühilduv</p>	<p>Komplekt</p> <p>Valamu ventiiliga</p>	<p>Artikkel</p> <p>127.0531.915</p>	<p>Hind €</p> <p>243,00</p>
---	--	---	------------------------------------

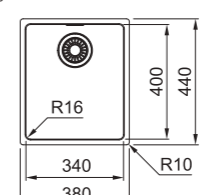

Tasapinnalise paigalduse süvend peab olema 1,1 mm

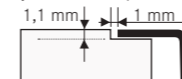



SPARK roostevabast terasest valamud

Lisad

1 112.0461.942
Nõrutuskauss- roostevaba teras
297 x 187 x 72 mm
€ 39,20



2 112.0271.449
Lõikelaud-plastik
210 x 476 mm
€ 49,00



Sisaldub komplektis

Mudel **SKX 651**
Aluskapp 60 cm
Mõõdud 1000 x 500 mm
Väljalõige 980 x 480 mm (R = 10 mm)
Kausi mõõtmed 340 / 420 / 160 + 170 / 280 / 80 mm
Kausi asukoht Pööratav
Paigaldamine Süstistatav
Materjal Roostevaba teras poleeritud
Ventii Nupuga avatav 3 1/2" ventiil
Ventii juhtimine Keeratav nupp
Tööpind min 30 mm paksune
Segisti augud Segisti ja nupu jaoks 2x 35 mm auk
Jäätmepurustaja Ühilduv
Sisaldub komplektis Roostevabast terasest nõrutuskauss
112.0461.942

Komplekt Artikkel Hind €
Valamu ventiiliga 101.0464.044 170,00

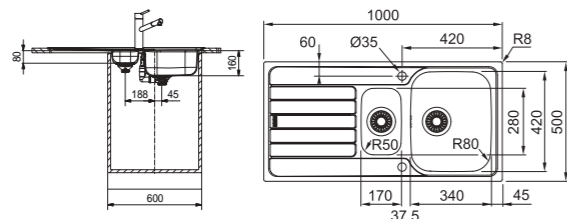

Mudel **SKX 611-86**
Aluskapp 45 cm
Mõõdud 860 x 500 mm
Väljalõige 840 x 480 mm (R = 10 mm)
Kausi mõõtmed 340 / 420 / 160 mm
Kausi asukoht Pööratav
Paigaldamine Süvistatav
Materjal Roostevaba teras poleeritud
Ventii Nupuga avatav 3 1/2" ventiil
Ventii juhtimine Keeratav nupp
Tööpind min 30 mm paksune
Segisti augud Segisti ja nupu jaoks 2x 35 mm auk
Jäätmepurustaja Ühilduv

Komplekt Artikkel Hind €
Valamu ventiiliga 101.0464.337 122,00

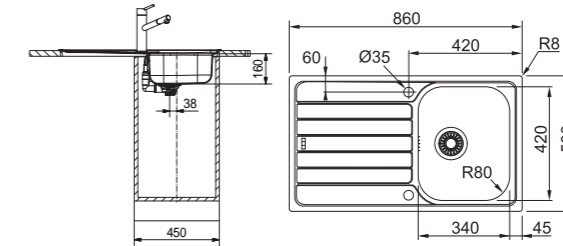

Mudel **SKX 611-79**
Aluskapp 45 cm
Mõõdud 790 x 500 mm
Väljalõige 770 x 480 mm (R = 10 mm)
Kausi mõõtmed 340 / 420 / 160 mm
Kausi asukoht Pööratav
Paigaldamine Süvistatav
Materjal Roostevaba teras poleeritud
Ventii Nupuga avatav 3 1/2" ventiil
Ventii juhtimine Keeratav nupp
Tööpind min 30 mm paksune
Segisti augud Segisti ja nupu jaoks 2x 35 mm auk
Jäätmepurustaja Ühilduv

Komplekt Artikkel Hind €
Valamu ventiiliga 101.0554.878 114,00

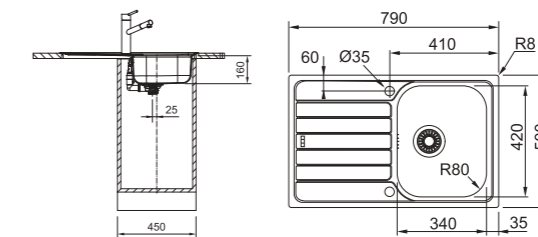

Mudel **SKX 611-63**
SKN 611-63
Aluskapp 45 cm
Mõõdud 635 x 500 mm
Väljalõige 615 x 480 mm (R = 10 mm)
Kausi mõõtmed 340 / 420 / 160 mm
Kausi asukoht Pööratav
Paigaldamine Süvistatav
Materjal Roostevaba teras poleeritud
Roostevaba teras matt
Ventii Nupuga või käsitsi avatav ventiil
Ventii juhtimine Nupuga või käsitsi
Tööpind min 30 mm paksune
Segisti augud SKX 611-63 Segisti ja nupu jaoks 2x 35 mm auk
SKN 611-63 aukudeta
Jäätmepurustaja Ühilduv

Komplekt Artikkel Hind €
SKX 611-63 103,00
Roostevaba teras poleeritud
Valamu ventiiliga 101.0554.877 103,00
SKN 611-63 64,60
Roostevaba teras matt
Süstistatav valamud 101.0605.605 55,00
Manuaalne 3 1/2" ventiil 112.0059.982 6,70
Kinnitused, tihendid, kleebitav mürasummuti 112.0485.906 2,90



või

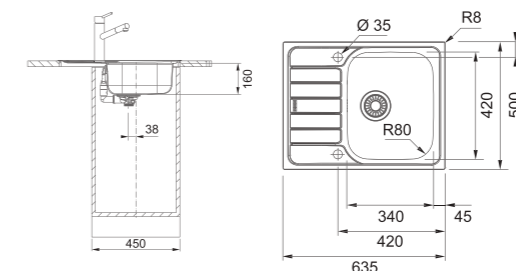

SPARK roostevabast terasest valamud

Lisad

1 112.0006.138

Nõrutuskauss- roostevaba teras
200 x 264 x 70 mm
€ 28,60



Sisaldub komplektis

1

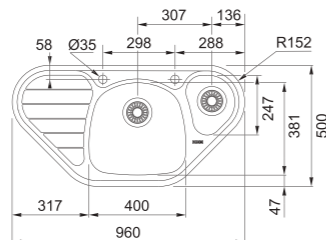
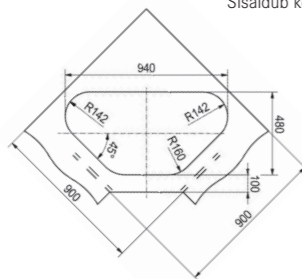

Mudel	Komplekt	Artikkel	Hind €
SKX 651-E			
Aluskapp 65 cm			
Möödud 960 x 500 mm			
Väljalõige Šablooni järgi			
Kausi mõõtmed 400 / 381 / 150 + 288 / 247 / 80 mm	Valamu ventiliga	101.0464.340	213,00
Kausi asukoht Kauss paremal			
Paigaldamine Süvistatav			
Materjal Roostevaba teras poleeritud			
Ventil Nupuga avatav 3/2" ventiil			
Ventili juhtimine Keeratav nupp			
Tööpind min 30 mm paksune			
Segisti augud Segisti ja nupu jaoks 2x 35 mm auk			
Jäätmepurustaja Ühilduv			
Sisaldub komplektis Roostevabast terasest nõrutuskauss 112.0006.138			

MIKADO roostevabast terasest valamud

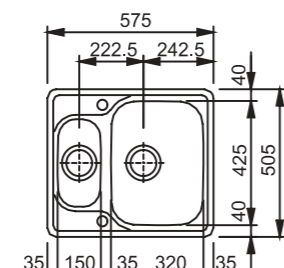
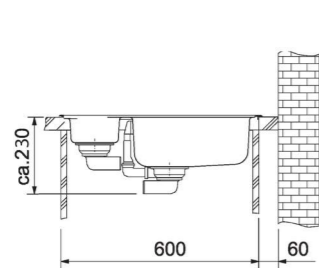

Mudel	Komplekt	Artikkel	Hind €
MOX 260			
Aluskapp 60 cm			
Möödud 575 x 505 mm			
Väljalõige SlimTop jaoks 558 x 488 mm (R = 22 mm)	Valamu ventiliga	127.0287.247	178,00
Kausi mõõtmed 320 / 425 / 150 + 150 / 300 / 80 mm			
Paigaldamine Slim-Top, tasapinnaline			
Materjal Roostevaba teras poleeritud			
Ventil Nupuga avatav 3/2" ventiil	Keeratav nupp		
Ventili juhtimine Keeratav nupp			
Tööpind min 30 mm paksune			
Segisti augud Segisti ja nupu jaoks 2x 35 mm auk			
Jäätmepurustaja Ühilduv			



RAPID roostevabast terasest valamud

Lisad

2 112.0040.682

Lõikelaud puit
340 x 400 mm
€ 46,00



2

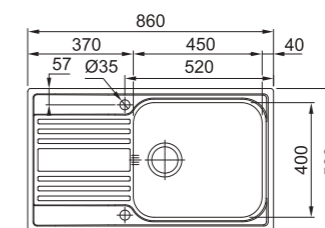

Mudel	Komplekt	Artikkel	Hind €
RPX 611-86XL			
Aluskapp 60 cm			
Möödud 860 x 500 mm			
Väljalõige 840 x 480 mm (R = 20 mm)	Valamu ventiliga	101.0498.889	183,00
Kausi mõõtmed 450 / 400 / 200 mm			
Kausi asukoht Pööratav			
Paigaldamine Süvistatav			
Materjal Roostevaba teras poleeritud			
Ventil Nupuga avatav 3/2" ventiil			
Ventili juhtimine Keeratav nupp			
Tööpind min 30 mm paksune			
Segisti augud Segisti ja nupu jaoks 2x 35 mm auk			
Jäätmepurustaja Ühilduv			



2

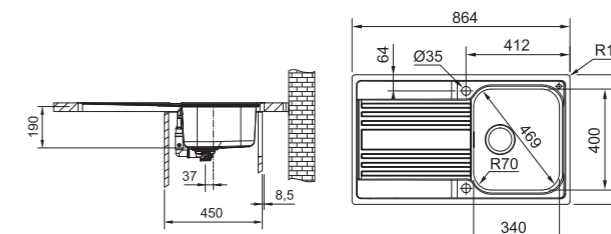

Mudel	Komplekt	Artikkel	Hind €
RPX 211			
Aluskapp 45 cm			
Möödud 864 x 514 mm			
Väljalõige SlimTop jaoks 855 x 495 mm (R = 20 mm)	Valamu ventiliga	127.0371.767	208,00
Kausi mõõtmed 340 / 400 / 190 mm			
Kausi asukoht Pööratav			
Paigaldamine Slim Top või tasapinnaline			
Materjal Roostevaba teras poleeritud			
Ventil Nupuga avatav 3/2" ventiil			
Ventili juhtimine Keeratav nupp			
Tööpind min 30 mm paksune			
Segisti augud Segisti ja nupu jaoks 2x 35 mm auk			
Jäätmepurustaja Ühilduv			



SMART roostevabast terasest valamud

Lisad

1 112.0040.682

Lõikelaud puit
340 x 400 mm
€ 47,00



Mudel **SRX 611-86XL**
Aluskapp 60 cm
Mõõdud 860 x 500 mm
Väljalõige 840 x 480 mm
Kausi mõõtmed 450 / 400 / 180 mm
Kausi asukoht Vasak või parem pool
Paigaldamine Süvistatav
Materjal Roostevaba teras poleeritud
Ventil Manuaalne 3/2" ventiil
Ventili juhtimine Põhjasõela käsitsi avamine
Tööpind min 30 mm paksune
Segisti augud Segisti jaoks 35 mm auk
Jäätmepurustaja Ühilduv

Kausi asukoht	Artikkel	Hind €
Kauss paremal	101.0356.850	179,00
Kauss vasakul	101.0356.849	179,00

1

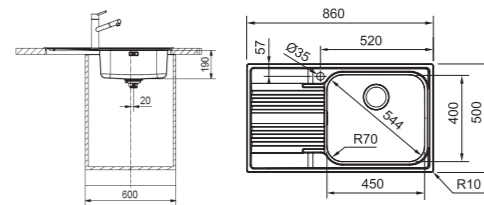

Mudel **SRX 611-86**
Aluskapp 45 cm
Mõõdud 860 x 500 mm
Väljalõige 840 x 480 mm
Kausi mõõtmed 340 / 400 / 180 mm
Kausi asukoht Vasak või parem pool
Paigaldamine Süvistatav
Materjal Roostevaba teras poleeritud
Ventil Manuaalne 3/2" ventiil
Ventili juhtimine Põhjasõela käsitsi avamine
Tööpind min 30 mm paksune
Segisti augud Segisti jaoks 35 mm auk
Jäätmepurustaja Ühilduv

Kausi asukoht	Artikkel	Hind €
Kauss paremal	101.0356.759	159,00
Kauss vasakul	101.0356.758	159,00

1

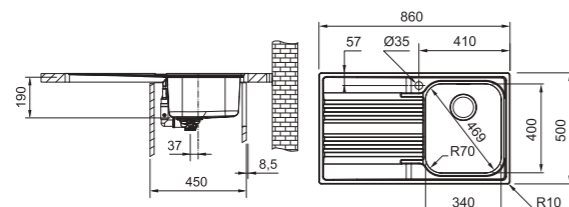

BELL roostevabast terasest valamud



UUDIS



Mudel **BCX 610-51**
Aluskapp 50 cm
Mõõdud 510 x 510 mm
Väljalõige 490 x 490 mm
Kausi mõõtmed 445 / 380 / 200 mm
Paigaldamine Süvistatav
Materjal Roostevaba teras poleeritud
Ventil Manuaalne 3/2" ventiil
Ventili juhtimine Põhjasõela käsitsi avamine
Tööpind min paksus 12 mm
Segisti augud Segisti jaoks 35 mm auk
Jäätmepurustaja Ühilduv

Komplekt	Artikkel	Hind €
Süvistatav valamud	101.0622.893	110,00

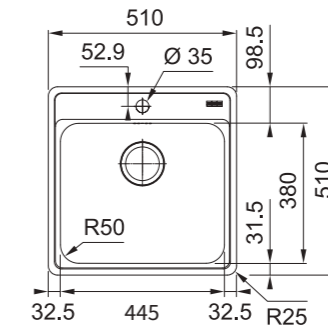



PAMIRA, RONDA ja RAMBLA roostevabast terasest valamud



Mudel **PMN 611**
PML 611
Aluskapp 45 cm
Mõõdud 770 x 500 mm
Väljalõige Šablooni järgi
Kausi mõõtmed Ø 410 / 160 mm
Paigaldamine Süvistatav
Kausi asukoht Pööratav
Materjal Roostevaba teras matt
Roostevaba teras linane
Ventil Manuaalne 3/2" ventiil
Ventili juhtimine Põhjasõela käsitsi avamine
Tööpind min 30 mm paksune
Segisti augud aukudeta
Jäätmepurustaja Ühilduv

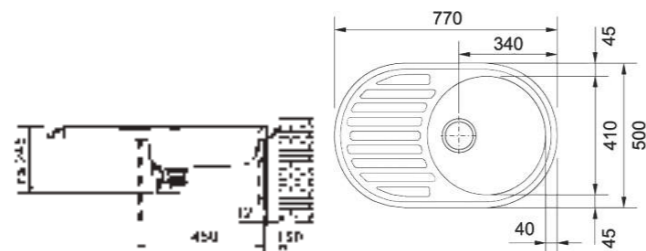

Komplekt	Artikkel	Hind €
PMN 611		82,50
Roostevaba teras matt		
Süvistatav valamu	101.0009.496	72,00
Manuaalne 3/2" ventiil	112.0006.341	10,50
PML 611		92,50
Roostevaba teras linane		
Süvistatav valamu	101.0009.497	82,00
Manuaalne 3/2" ventiil	112.0006.341	10,50



Mudel **ROX 610-41**
RON 610-41
ROL 610-41
Aluskapp 45 cm
Mõõdud Ø 510 mm
Väljalõige Ø 490 mm
Kausi mõõtmed Ø 410 / 175 mm
Paigaldamine Süvistatav
Materjal Roostevaba teras poleeritud
Roostevaba teras matt
Roostevaba teras linane
Ventil Manuaalne 3/2" ventiil
Ventili juhtimine Põhjasõela käsitsi avamine
Tööpind min 30 mm paksune
Segisti augud Segisti jaoks 35 mm auk
Jäätmepurustaja Ühilduv

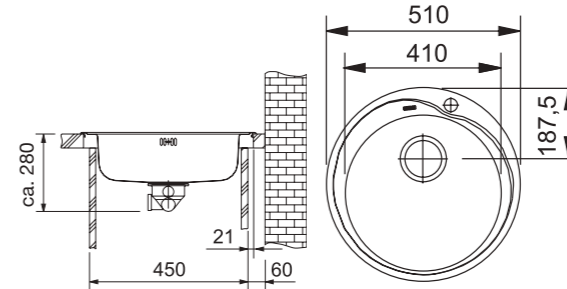

Mudel **RAX 610-38**
RAN 610-38
RAL 610-38
Aluskapp 45 cm
Mõõdud Ø 430 mm
Väljalõige Ø 414 mm
Kausi mõõtmed Ø 380 / 180 mm
Paigaldamine Süvistatav
Materjal Roostevaba teras poleeritud
Roostevaba teras matt
Roostevaba teras linane
Ventil Manuaalne 3/2" ventiil
Ventili juhtimine Põhjasõela käsitsi avamine
Tööpind min 30 mm paksune
Segisti augud aukudeta
Jäätmepurustaja Ühilduv

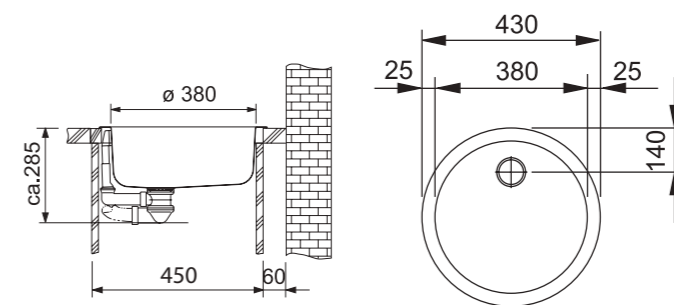

Komplekt	Artikkel	Hind €
ROX 610-41		62,00
Roostevaba teras poleeritud		
Süvistatav valamu	101.0017.919	55,00
Manuaalne 3/2" ventiil	112.0006.351	7,00
RON 610-41		55,00
Roostevaba teras matt		
Süvistatav valamu	101.0000.561	48,00
Manuaalne 3/2" ventiil	112.0006.351	7,00
ROL 610-41		64,00
Roostevaba teras linane		
Süvistatav valamu	101.0000.562	57,00
Manuaalne 3/2" ventiil	112.0006.351	7,00
RAX 610-38		60,00
Roostevaba teras poleeritud		
Süvistatav valamu	101.0017.998	53,00
Manuaalne 3/2" ventiil	112.0006.351	7,00
RAN 610-38		50,00
Roostevaba teras matt		
Süvistatav valamu	101.0017.901	43,00
Manuaalne 3/2" ventiil	112.0006.351	7,00
RAL 610-38		61,00
Roostevaba teras linane		
Süvistatav valamu	101.0017.915	54,00
Manuaalne 3/2" ventiil	112.0006.351	7,00

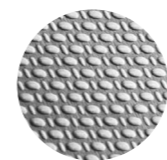

Linase dekooriga pind on kriimustustele väga vastupidav ja tundub puhastuste vahel ühtlaselt puhas. Pind sobib hästi alumiiniumist ja matt roostevabast terasest segisti ja lisadega.



EUROFORM roostevabast terasest valamud



Mudel **EFN 651-78**
 Aluskapp **60 cm**
 Mõõdud **780 x 475 mm**
 Väljalõige **760 x 455 mm**
 Kausi mõõtmed **355 / 395 / 150 + 150 / 300 / 65 mm**
 Kausi asukoht **Pööratav**
 Paigaldamine **Süvistatav**
 Materjal **Roostevaba teras matt**
 Ventil **Manuaalne**
 Ventili juhtimine **Põhjasõela käsitsi avamine**
 Tööpind **min 30 mm paksune**
 Segisti augud **aukudeta**
 Jäätmepurustaja **Ühilduv**

Komplekt	Artikkel	Hind €
EFN 651-78		97,10
Roostevaba teras matt		
Süvistatav valamu	101.0035.407	70,00
Manuaalne 3½" ventiil	112.0006.274	27,10

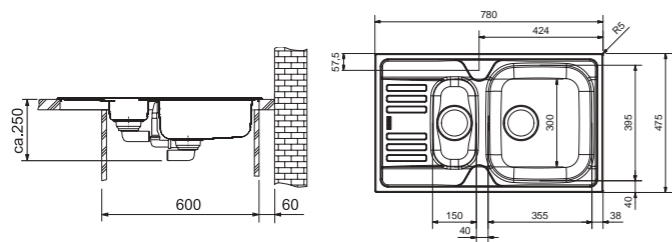

Mudel **EFX 614-78**
EFN 614-78
 Aluskapp **50 cm**
 Mõõdud **780 x 475 mm**
 Väljalõige **760 x 455 mm**
 Kausi mõõtmed **355 / 395 / 150 mm**
 Kausi asukoht **Pööratav**
 Paigaldamine **Süvistatav**
 Materjal **Roostevaba teras poleeritud**
Roostevaba teras matt
 Ventil **Nupuga või käsitsi avatav ventiil**
 Ventili juhtimine **Nupuga või käsitsi**
 Tööpind **min 30 mm paksune**
 Segisti augud **EFX 614-78 Segisti ja nupu jaoks 2x 35 mm auk**
EFN 614-78 aukudeta
 Jäätmepurustaja **Ühilduv**

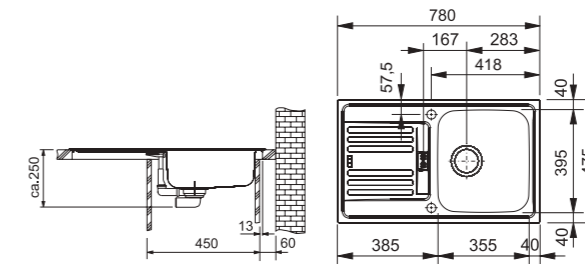

Komplekt	Artikkel	Hind €
EFX 614-78		99,70
Roostevaba teras poleeritud		
Süvistatav valamu	101.0016.461	80,00
Ventiil 3½" nupuga	112.0006.331	19,70

Komplekt	Artikkel	Hind €
EFN 614-78		81,50
Roostevaba teras matt		
Süvistatav valamu	101.0017.705	73,00
Manuaalne 3½" ventiil	112.0006.332	8,50



Mudel **EFX 620-78**
 Aluskapp **80 cm**
 Mõõdud **780 x 475 mm**
 Väljalõige **760 x 455 mm**
 Kausi mõõtmed **2x 335 / 395 / 150 mm**
 Paigaldamine **Süvistatav**
 Materjal **Roostevaba teras poleeritud**
 Ventil **Nupuga või käsitsi avatav ventiil**
 Ventili juhtimine **Nupuga või käsitsi**
 Tööpind **min 30 mm paksune**
 Segisti augud **Segisti ja nupu jaoks 2x 35 mm auk**
 Jäätmepurustaja **Ühilduv**

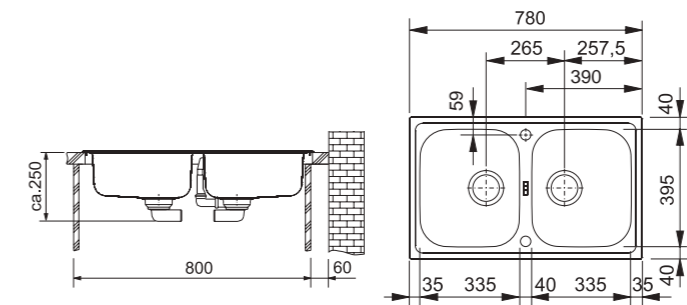

Komplekt	Artikkel	Hind €
EFX 620-78		138,30
Roostevaba teras poleeritud		
Süvistatav valamu	101.0035.362	99,00
Ventiil 3½" nupuga	112.0006.218	39,30



LOGICA LINE roostevabast terasest valamud

Lisad

1 112.0040.682

Lõikelaud puit
340 x 400 mm
€ 47,00



Mudel **LLX 611**
Aluskapp 45 cm
Mõõdud 790 x 500 mm
Väljalõige 770 x 480 mm
Kausi mõõtmed 340 / 400 / 195 mm
Kausi asukoht Vasak või parem pool
Paigaldamine Süvistatav
Materjal Roostevaba teras poleeritud
Ventil Manuaalne 3 1/2" ventil
Ventili juhtimine Põhjasõela käsitsi avamine
Tööpind min 30 mm paksune
Segisti augud Segisti jaoks 35 mm auk
Jäätmeपुरustaja Ühilduv

	Kausi asukoht	Artikkel	Hind €
	Kauss paremal	101.0085.773	165,00
	Kauss vasakul	101.0085.772	165,00

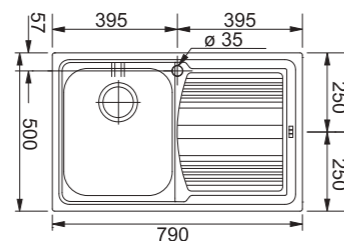

1



EUROSET roostevabast terasest valamud



Mudel **ESN 614**
Aluskapp 45 cm
Mõõdud 860 x 435 mm
Väljalõige 840 x 415 mm
Kausi mõõtmed 370 / 340 / 140 mm
Paigaldamine Süvistatav
Kausi asukoht Pööratav
Materjal Roostevaba teras matt
Ventil Ventil 1 1/2" korgiga
Tööpind min 30 mm paksune
Segisti augud aukudeta

Komplekt	Artikkel	Hind €
	ESN 614	53,20
	Süvistatav valamud	101.0288.025 48,00
	Manuaalne 3 1/2" ventil	112.0006.318 5,20

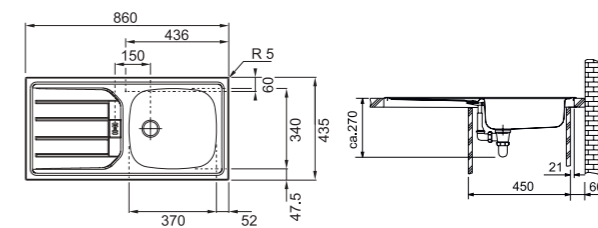

KAPILE PAIGALDATAVAD VALAMUD



Mudel **DSN 711**
Aluskapp 80 cm
Mõõdud 800 x 600 mm
Kausi mõõtmed 340 / 370 / 150 mm
Paigaldamine Kapile paigaldatav valamud
Kausi asukoht Pööratav
Materjal Roostevaba teras matt
Ventil Ventil 1 1/2" korgiga
Segisti augud aukudeta

Komplekt	Artikkel	Hind €
	DSN 711	73,90
	Kapile paigaldatav valamud	103.0013.774 70,00
	Ventil 1 1/2" korgiga	112.0008.398 3,90

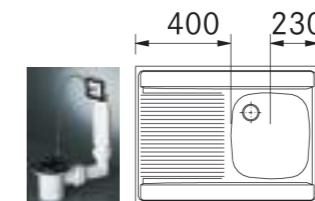



EUROSTAR roostevabast terasest valamud



Mudel **ETN 614 NOVA**
ETL 614 NOVA
Aluskapp 45 cm
Mõõdud 780 x 435 mm
Väljalõige 760 x 415 mm
Kausi mõõtmed 360 / 355 / 140 mm
Paigaldamine Süvistatav
Kausi asukoht Pööratav
Materjal Roostevaba teras või roostevaba teras linane
Ventil Manuaalne 3 1/2" ventiil
Ventili juhtimine Põhjasõela käsitsi avamine
Tööpind min 30 mm paksune
Segisti augud aukudeta
Jäätmepurustaja Ühilduv

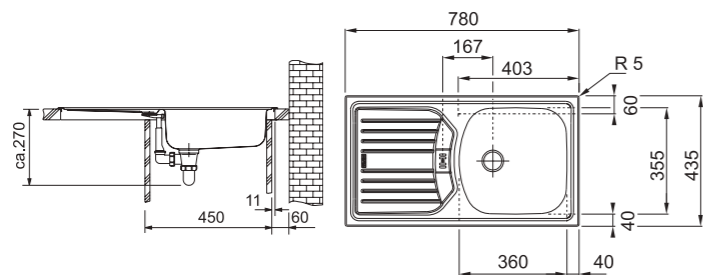

Komplekt	Artikkel	Hind €
ETN 614 NOVA		61,50
Roostevaba teras matt		
Süvistatav valamud	101.0288.027	53,00
Manuaalne 3 1/2" ventiil	112.0006.332	8,50
ETL 614 NOVA		72,50
Roostevaba teras linane		
Süvistatav valamud	101.0288.041	64,00
Manuaalne 3 1/2" ventiil	112.0006.332	8,50



Linase dekooriga pind on kriimustustele väga vastupidav ja tundub puhastuste vahel ühtlaselt puhas. Pind sobib hästi alumiiniumist ja matt roostevabast terasest segisti ja lisadega.



Mudel **ETN 611-58**
ETL 611-58
Aluskapp 40 cm
Mõõdud 580 x 510 mm
Väljalõige 560 x 490 mm
Kausi mõõtmed 340 / 355 / 145 mm
Paigaldamine Süvistatav
Kausi asukoht Pööratav
Materjal Roostevaba teras või roostevaba teras linane
Ventil Ventii 1 1/2" korgiga
Tööpind min 30 mm paksune
Segisti augud aukudeta

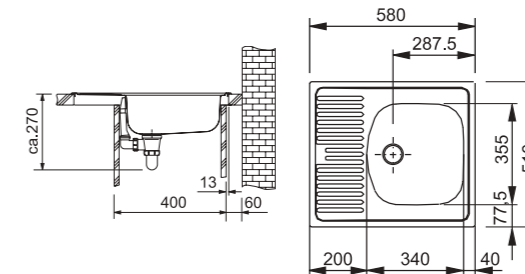

Komplekt	Artikkel	Hind €
ETN 611-58		63,90
Süvistatav valamud	101.0009.362	57,00
Ventii 1 1/2" korgiga	112.0006.230	6,90
ETL 611-58		73,90
Roostevaba teras linane		
Süvistatav valamud	101.0009.363	67,00
Ventii 1 1/2" korgiga	112.0006.230	6,90



Mudel **ETN 610**
Aluskapp 45 cm
Mõõdud 455 x 435 mm
Väljalõige 435 x 415 mm
Kausi mõõtmed 360 / 355 / 140 mm
Paigaldamine Süvistatav
Materjal Roostevaba teras matt
Ventil Ventii 1 1/2" korgiga
Tööpind min 30 mm paksune
Segisti augud aukudeta

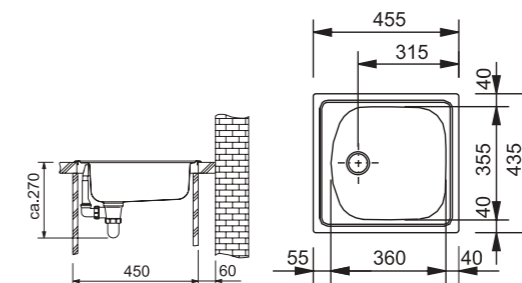

Komplekt	Artikkel	Hind €
ETN 610		51,90
Süvistatav valamud	101.0009.909	45,00
Ventii 1 1/2" korgiga	112.0006.230	6,90

RUUMI SÄÄSTVA SIFOONI PAIGALDAMINE



112.0006.412
Universaalne ruumisäästlik sifoon
1 1/2" 1 m
€ 4,40



FRAGRANIT VALAMUD



- ① Spetsiaalne Sanitized® lisand materjalile tagab pideva 24-tunnise kaitse ja hoiab ära bakterite paljunemise.



- ② Kaetud ülevool on paigutatud võimalikult kõrgele ja seda on lihtne puhastada.



- ③ Erinevad paigaldusvõimalused võimaldavad teil valamu paigaldada kas Slim Top variandis või tasapinnaliseks. See muudab valamu ja tööpinna vahelise piiri märkamatuks.



- ④ Sügav kaus, mis võimaldab teil pesta isegi suuri potte või plaate ja hoida kõik puhtana.



- ⑤ Lõikelaud võib olla ka serveerimispind.



- ⑥ Fast Fix süsteem muudab valamu paigaldamise väga kiireks ja ilma täiendavate tööriistadeta.





FRAGRANIT VÄRVID



MIS MATERJAL ON FRAGRANIT+ ?

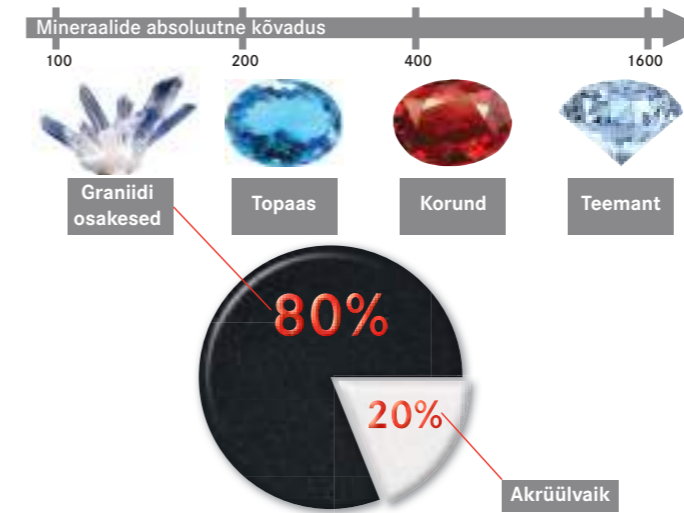

FrAGRANIT sisaldab 80% graniiti ja seetõttu õigustatult kutsutakse sellest materjalist valamuid graniitvalamuteks. Ülejäänud 20% on eriakrüül, mis seob graniidiosakesed ja annab tootele paindlikkuse.

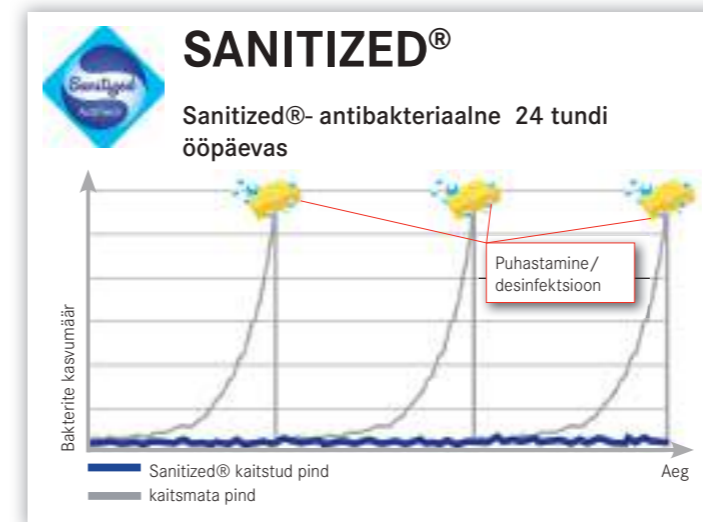

Köögi hügieeni lahendus: FrAGRANIT märkega Sanitized® tähendab, et valamud on antibakteriaalse toimega.

Täiuslikult hügieeniline. Köögid on bakterite leviku seisukohalt kriitilised ruumid. Sellepärast tuleb köögis hügieenile erilist tähelepanu pöörata. Tavalisel pinnal levivad bakterid juba 20 minuti jooksul. Hügieenil on kriitiline tähtsus kohtadel, kus toimub toidu ettevalmistamine. Üheks selliseks kohaks on valamud. Sanitized® ei asenda reeglipäraselt puhastamist, kuid aitab valamul hügieeniliseks püsida.

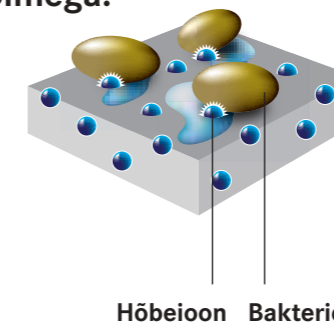

FRANKE FRAGRANIT+ ON SUUREPÄRASTE OMADUSTEGA MATERJAL

- Vastupidav kriimustustele ja hõõrdumistele**
Valamu tehakse materjalist, mis on kõvaduselt 4. kohal maailmas. Metallesembed võivad küll valamuga kokkupuutel jätta jälgi, kuid need on kergesti mahapestavad.
- Kõrge hügieeni tase**
Valamu valmistamisel kasutatakse väga väikseid graniidiosakesi, mis teevad valamud pinna siledaks ja kergesti hooldatavaks.
- Plekkidele vastupidav**
FrANKE FrAGRANIT+ valamud on kõigile köögis tekkitavatele plekkidele vastupidavad. Pikemat aega seisnud plekid vajavad eemaldamiseks ka rohkem aega.
- Löögikindel**
Materjal on köögis eettulevate juhtumite suhtes vastupidav. Katsed tõestavad, et valamud ei juhtu üldreeglina midagi, kui köögiriistad sellele kukuvad.
- UV kiirguse kaitse**
FRAGRANIT+ materjal on vastupidav UV kiirguse suhtes ja seepärast valamud ei muuda oma esialgset värvi. Valamu materjal on läbinisti ühte ja sama värvi.
- Kõrge temperatuuri taluvus**
FrAGRANIT+ valamud on vastupidavad kuni 280°C kuumusele.



MUST JA MUST SOBIVAD

Köögivalamute ja segistite must toon muutub üha populaarsemaks. Seetõttu oleme täiendanud olemasolevat värvipakkumist MUST MATT tooniga. Uus Centro seeria on saadaval mattvärvides ning Fresno, Mythos, Kubus 2 ja FX sarjades lisandub täiesti must toon. Sellega on ühtse köögikujunduse loomine nüüd veelgi lihtsam.



Fresno
FSG 611-88
877 x 495 mm
47. lk.



Kubus 2
KNG 110-62
760 x 460 mm
102. lk.



Kubus 2
KNG 110-52
560 x 460 mm
103. lk.



Kubus 2
KNG 110-37
410 x 460 mm
103. lk.



Centro
CNG 611-86
860 x 500 mm
66. lk.



Centro
CNG 611-78
780 x 500 mm
67. lk.



Centro
CNG 611-62
620 x 500 mm
67. lk.



Centro
CNG 610-54
590 x 500 mm
68. lk.



Centro
CNG 610-39
440 x 500 mm
69. lk.



Olemasolevatele mustadele mattmudelitele oleme lisanud veel mitu seeriat - Icon, Lift ja Centro. Nii tööstuslik must toon kui ka must matt sobivad köögiseadmete elementidega ja loovad köögis harmoonilise keskkonna. Köögi puhtuse ja korrasoleku tagamiseks on saadaval ka must matt dosaator.



VITAL
115. lk.



ATLAS NEO SENSOR **UUDIS**
119. lk.



MYTHOS
128. lk.



ATLAS-NEO
122. lk.



ICON **UUDIS**
134. lk.



LIFT **UUDIS**
135. lk.



PESCARA UP&DOWN
132. lk.



PESCARA 360°
132. lk.



ACTIVE PLUS
136. lk.



NEPTUNE-EVO
139. lk.



CENTRO **UUDIS**
141. lk.



SEEBIDOSAATORID
ACTIVE PLUS
151. lk.

FRAGRANIT VALAMUD ALUSKAPI LAIUSE JÄRGI

60
cm



Fresno
FSG 611-88
877 x 495 mm
47. lk.



Mythos
MTG 651-100
1000 x 515 mm
48. lk.



Maris
MRG 651
970 x 500 mm
52. lk.



Basis
BFG 651
970 x 500 mm
58. lk.



Urban
UBG 651-100
1000 x 500 mm
62. lk.



Maris
MRG 651-78
780 x 500 mm
53. lk.



Basis
BFG 651-78
780 x 500 mm
59. lk.



Mythos
MTG 611
1000 x 515 mm
49. lk.



FX
FXG 611-100
1000 x 500 mm
50. lk.



Urban
UBG 611-100
1000 x 500 mm
63. lk.



Maris
MRG 611-100
970 x 500 mm
53. lk.



Maris
MRG 611-100XL
970 x 500 mm
53. lk.



Maris
MRG 611-78XL
780 x 500 mm
54. lk.



Urban
UBG 611-78XL
780 x 500 mm
64. lk.



Maris
MRG 610-58
585 x 520 mm
56. lk.



Urban
UBG 610-56
560 x 500 mm
65. lk.



Centro
CNG 610-54
590 x 500 mm
68. lk.



50
cm



Maris
MRG 610-42
425 x 520 mm
57. lk.



Urban
UBG 611-86
860 x 500 mm
63. lk.



UUDIS
Centro
CNG 611-86
860 x 500 mm
66. lk.

45
cm



FX
FXG 611-78
780 x 500 mm
51. lk.



Maris
MRG 611
780 x 500 mm
55. lk.



Urban
UBG 611-78
780 x 500 mm
63. lk.



UUDIS
Centro
CNG 611-78
780 x 500 mm
67. lk.



Basis
BFG 611-86
860 x 500 mm
59. lk.



Basis
BFG 611
780 x 500 mm
60. lk.



Strata
STG 614
860 x 435 mm
72. lk.



Strata
STG 614-78
780 x 435 mm
73. lk.



Maris
MRG 611-62
620 x 500 mm
55. lk.



Basis
BFG 611-62
620 x 500 mm
61. lk.



Urban
UBG 611-62
620 x 500 mm
65. lk.



UUDIS
Centro
CNG 611-62
620 x 500 mm
67. lk.



UUDIS
Centro
CNG 610-39
440 x 500 mm
69. lk.



Ronda
ROG 611
770 x 500 mm
70. lk.



Ronda
ROG 611-62
620 x 500 mm
71. lk.



Ronda
ROG 610-41
Ø 510 mm
71. lk.

80
cm



Basis
BFG 620
860 x 500 mm
61. lk.

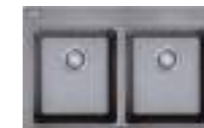

Maris
MRG 620
800 x 520 mm
57. lk.

Nurgavalamud



Maris
MRG 612-E
960 x 500 mm
57. lk.

FRAGRANIT VALAMU VÄRVID SEERiate KAUPA



Sērija	Mudel	Lpp	polaarvalge	beež	cashmere	kivihall	grafiit	onyx	must matt
Fresno	FSG 611-88	47						•	•
Mythos	MTG 651-100	48	•		•	•	•	•	
	MTG 611-100	49	•		•	•	•	•	
FX	FXG 611-100	50	•		•	•	•	•	
	FXG 611-78	51	•		•	•	•	•	
Maris	MRG 651	52	•		•	•	•	•	
	MRG 651-78	53	•		•	•	•	•	
	MRG 611-100	53	•		•	•	•	•	
	MRG 611-100XL	53	•		•	•	•	•	
	MRG 611-78XL	54	•		•	•	•	•	
	MRG 611	55	•		•	•	•	•	
	MRG 611-62	55	•		•	•	•	•	
	MRG 610-58	56	•		•	•	•	•	
	MRG 610-42	57	•		•	•	•	•	
	MRG 620	57	•		•	•	•	•	
Basis	MRG 612-E	57						•	
	BFG 651	58	•	•	•	•	•	•	
	BFG 651-78	59	•	•	•	•	•	•	
	BFG 611-86	59	•	•	•	•	•	•	
	BFG 61	60	•	•	•	•	•	•	
	BFG 611-62	61	•	•	•	•	•	•	
Urban	BFG 620	61	•	•	•	•	•	•	
	UBG 651-100	62	•		•	•	•	•	
	UBG 611-100	63	•		•	•	•	•	
	UBG 611-86	63	•		•	•	•	•	
	UBG 611-78	63	•		•	•	•	•	
	UBG 611-78XL	64	•		•	•	•	•	
	UBG 611-62	65	•		•	•	•	•	
Centro	UBG 10-56	65	•		•	•	•	•	
	CNG 611-86	66	•		•	•	•	•	•
	CNG 611-78	67	•		•	•	•	•	•
	CNG 611-62	67	•		•	•	•	•	•
	CNG 610-54	68				•		•	•
Ronda	CNG 610-39	69				•		•	•
	ROG 611	70		•			•		
	ROG 61-62	71		•			•		
Strata	ROG 610-41	71	•	•		•	•	•	
	STG 614	72	•	•		•	•	•	
	STG 614-78	73	•	•		•	•	•	



FRESNO Fragranit valamud



Mudel **FSG 611-88**
 Aluskapp 60 cm
 Mõõdud 877 x 495 mm
 Väljalõige 845 x 463 mm (R = 20 mm)
 Kausi mõõtmed 496 / 425 / 195 mm
 Paigaldamine Süvistatav
 Kausi asukoht Pööratav
 Materjal Fragranit+ / antibakteriaalne
 Ventiiil Sealhulgas ventiil 3/4" vajutusnupuga
 Ventiiili juhtimine Vajutusnupp ümmargune roostevaba teras
 Ülevool Katteplaadiga ülevool
 Segisti augud aukudeta (2 x 35 mm altpoolt puuritud augud)
 Ventiiili kate Nelinurkne roostevabast terasest kate
 Sisaldub komplektis Rollmatt 112.0520.938
 Erimärkused Kraan ja ventiil tuleb enne valamud paigaldamist paigaldada
 Kui valamud paigaldatakse 60 cm kappi, võib külgeina paksus olla maksimaalselt 16 mm

Värv	Artikkel	Hind €
onyx	114.0593.108	577,00
must matt	114.0627.323	577,00

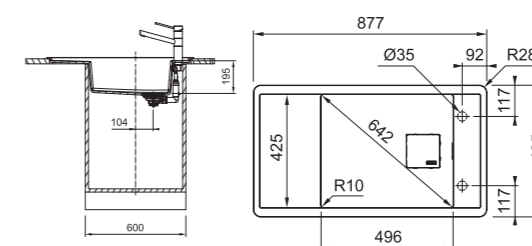



MYTHOS Fragranit valamud

Lisad

1 112.0018.817
Nõrutuskauss- roostevaba teras
160 x 405 mm
€ 39,20



2 112.0017.900
Lõikelaud- klaas
280 x 408 mm
€ 39,20



Sisaldub komplektis

Mudel	Värv	Artikkel	Hind €
MTG 651-100			
Aluskapp 60 cm			
Mõõdud 1000 x 515 mm			
Väljalõige 980 x 495 mm (R=10 mm)			
Kausi mõõtmed 360 / 390 / 190 + 160 / 390 / 130 mm			
Paigaldamine Süvistatav			
Kausi asukoht Vasak või parem pool			
Materjal Fragranit+ / antibakteriaalne			
Ventiil Sealhulgas ventiil 3½" vajutusnupuga			
Ventiili juhtimine Vajutusnupp ümmargune roostevaba teras			
Ülevool Katteplaadiga ülevool			
Segisti augud aukudeta (3 x 35 mm altpoolt puuritud augud)			
Sisaldub komplektis Roostevabast terasest nõrutuskauss 112.0018.817			



Suur kauss paremal

polaarvalge 114.0476.969 424,00

cashmere 114.0476.987 424,00

kivihall 114.0476.967 424,00

grafiit 114.0476.965 424,00

onyx 114.0476.963 424,00

Suur kauss vasakul

polaarvalge 114.0476.970 424,00

cashmere 114.0476.988 424,00

kivihall 114.0476.968 424,00

grafiit 114.0476.966 424,00

onyx 114.0476.964 424,00

1 **2**

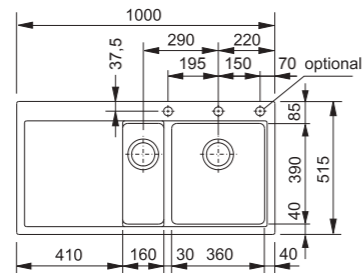
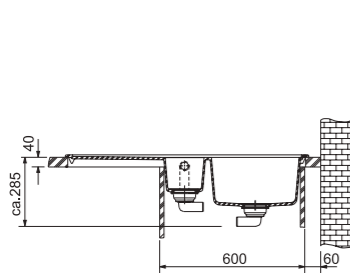

1 **2**



Mudel **MTG 611**
Aluskapp 60 cm
Mõõdud 1000 x 515 mm
Väljalõige 980 x 495 mm (R=10 mm)
Kausi mõõtmed 500 / 390 / 190 mm
Paigaldamine Süvistatav
Kausi asukoht Vasak või parem pool
Materjal Fragranit+ / antibakteriaalne
Ventiil Sealhulgas ventiil 3½" vajutusnupuga
Ventiili juhtimine Vajutusnupp ümmargune roostevaba teras
Ülevool Katteplaadiga ülevool
Segisti augud aukudeta (3 x 35 mm altpoolt puuritud augud)

Värv Artikkel Hind €



Suur kauss

paremal

polaarvalge 114.0477.021 381,00

cashmere 114.0477.041 381,00

kivihall 114.0476.999 381,00

grafiit 114.0476.997 381,00

onyx 114.0476.995 381,00

Suur kauss vasakul

polaarvalge 114.0477.022 381,00

cashmere 114.0477.044 381,00

kivihall 114.0477.000 381,00

grafiit 114.0476.998 381,00

onyx 114.0476.996 381,00

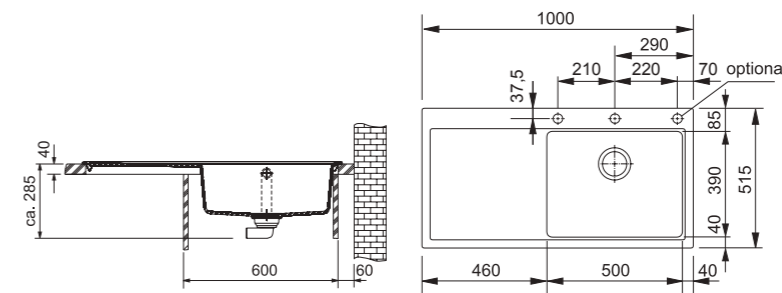



FX Fragranit valamud

Lisad

- | | | | |
|--|---------------|---|--------------|
| 1 | 112.05.12.280 | 2 | 112.0595.334 |
| Plastikust nõrutuskauss hall
456 x 179 x 92 mm
€ 19,20 | | Lõikelaud puit
532 x 280 mm
€ 39,60 | |

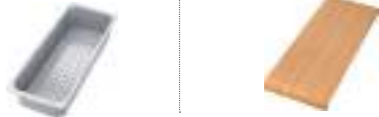

Mudel FXG 611-100	Värv	Artikkel	Hind €
Aluskapp 60 cm	● polaarvalge	114.05.12.361	377,00
Möödud 1000 x 500 mm	● cashmere	114.05.12.340	377,00
Väljalõige 980 x 480 mm (R=10 mm)	● kivihall	114.05.12.362	377,00
Kausi mõõtmed 465 /435 /200 mm	● grafiit	114.05.12.337	377,00
Paigaldamine Süvistatav	● onyx	114.05.12.339	377,00
Kausi asukoht Pööratav			
Materjal Fragranit+ / antibakteriaalne			
Ventiil Sealhulgas ventiil 3½" vajutusnupuga			
Ventiili juhtimine Vajutusnupp ümmargune roostevaba teras			
Ülevool Katteplaadiga ülevool			
Segisti augud aukudeta (2 x 35 mm altpoolt puuritud augud)			

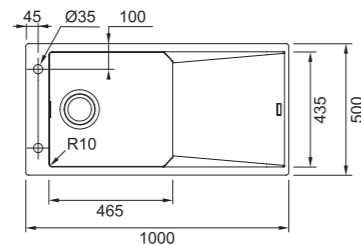

Mudel FXG 611-78	Värv	Artikkel	Hind €
Aluskapp 45 cm	● polaarvalge	114.05.12.409	356,00
Möödud 780 x 500 mm	● cashmere	114.05.12.408	356,00
Väljalõige 760 x 480 mm (R=10 mm)	● kivihall	114.05.12.410	356,00
Kausi mõõtmed 325 /435 /200 mm	● grafiit	114.05.12.405	356,00
Paigaldamine Süvistatav	● onyx	114.05.12.407	356,00
Kausi asukoht Pööratav			
Materjal Fragranit+ / antibakteriaalne			
Ventiil Sealhulgas ventiil 3½" vajutusnupuga			
Ventiili juhtimine Vajutusnupp ümmargune roostevaba teras			
Ülevool Katteplaadiga ülevool			
Segisti augud aukudeta (2 x 35 mm altpoolt puuritud augud)			

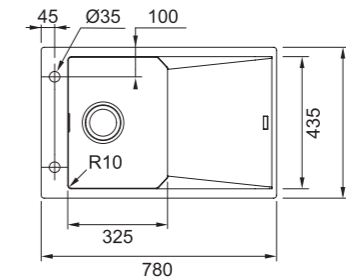



MARIS Fragranit valamud

Lisad

1 112.0057.214	2 112.0066.060	3 112.0075.642	4 112.0595.334
Nõrutuskauss- roostevaba teras 150 x 325 x 80 mm € 48,80	Roostevabast terasest nõrutus- kauss plastkäepidemetega 156 x 417 x 54 mm € 91,50	Rullmatt paindub 366 x 326 mm € 47,40	Lõiklaud puit 532 x 280 mm € 39,60

Mudel	MRG 651	Värv	Artikkel	Hind €
Aluskapp	60 cm	polaarvalge	114.0055.823	366,00
Mõõdud	970 x 500 mm	cashmere	114.0302.676	366,00
Väljalõige	950 x 480 mm (R=11 mm)	kivihall	114.0055.819	366,00
Kausi mõõtmed	350 / 425 / 200 + 160 / 300 / 120 mm	grafiit	114.0055.701	366,00
Paigaldamine	Süvistatav	onyx	114.0176.602	366,00
Kausi asukoht	Pööratav			
Materjal	Fragranit+ / antibakteriaalne			
Ventiil	Nupuga avatav 3½" ventiil			
Ventiili juhtimine	Ümar keeratav nupp sõela avamiseks või sulgemiseks			
Ventiil väikese kausi jaoks	Manuaalne 3½" ventiil			
Ülevool	Katteplaadiga ülevool			
Segisti augud	aukudeta (2 x 35 mm altpoolt puuritud augud)			
Sisaldub komplektis	Roostevabast terasest nõrutuskauss 112.0057.214			

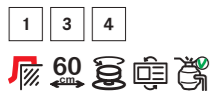
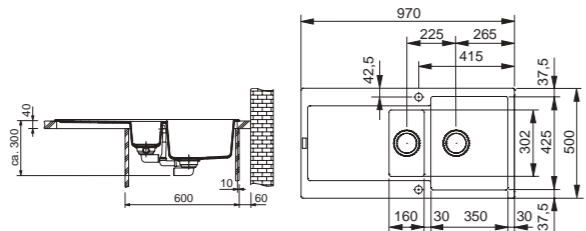

Mudel	MRG 651-78	Värv	Artikkel	Hind €
Aluskapp	60 cm	polaarvalge	114.0253.334	335,00
Mõõdud	780 x 500 mm	cashmere	114.0302.683	335,00
Väljalõige	760 x 480 mm (R=11 mm)	kivihall	114.0253.335	335,00
Kausi mõõtmed	350 / 425 / 200 + 160 / 300 / 120 mm	grafiit	114.0253.330	335,00
Paigaldamine	Süvistatav	onyx	114.0253.333	335,00
Kausi asukoht	Pööratav			
Materjal	Fragranit+ / antibakteriaalne			
Ventiil	Nupuga avatav 3½" ventiil			
Ventiili juhtimine	Ümar keeratav nupp sõela avamiseks või sulgemiseks			
Ventiil väikese kausi jaoks	Manuaalne 3½" ventiil			
Ülevool	Katteplaadiga ülevool			
Segisti augud	aukudeta (4 x 35 mm altpoolt puuritud augud)			
Sisaldub komplektis	Roostevabast terasest nõrutuskauss 112.0057.214			

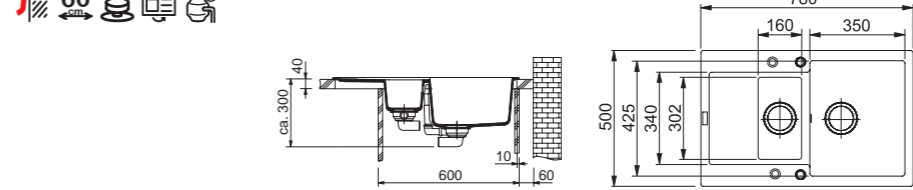

Mudel	MRG 611-100	Värv	Artikkel	Hind €
Aluskapp	60 cm	polaarvalge	114.0176.596	336,00
Mõõdud	970 x 500 mm	cashmere	114.0302.693	336,00
Väljalõige	950 x 480 mm (R=11 mm)	kivihall	114.0176.594	336,00
Kausi mõõtmed	450 / 425 / 200 mm	grafiit	114.0176.593	336,00
Paigaldamine	Süvistatav	onyx	114.0176.600	336,00
Kausi asukoht	Pööratav			
Materjal	Fragranit+ / antibakteriaalne			
Ventiil	Nupuga avatav 3½" ventiil			
Ventiili juhtimine	Ümar keeratav nupp sõela avamiseks või sulgemiseks			
Ülevool	Katteplaadiga ülevool			
Segisti augud	aukudeta (4 x 35 mm altpoolt puuritud augud)			

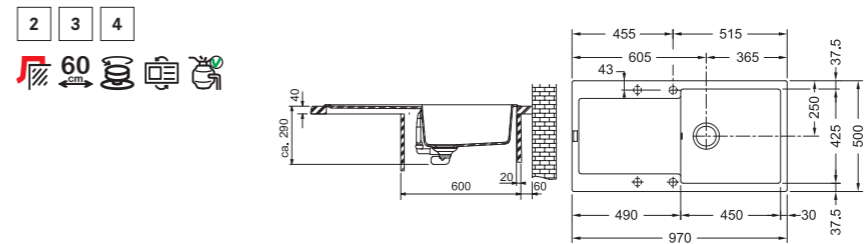

Mudel	MRG 611-100XL	Värv	Artikkel	Hind €
Aluskapp	60 cm	polaarvalge	114.0378.095	336,00
Mõõdud	970 x 500 mm	cashmere	114.0378.121	336,00
Väljalõige	950 x 480 mm (R=11 mm)	kivihall	114.0378.124	336,00
Kausi mõõtmed	490 / 425 / 200 mm	grafiit	114.0378.125	336,00
Paigaldamine	Süvistatav	onyx	114.0378.126	336,00
Kausi asukoht	Pööratav			
Materjal	Fragranit+ / antibakteriaalne			
Ventiil	Nupuga avatav 3½" ventiil			
Ventiili juhtimine	Ümar keeratav nupp sõela avamiseks või sulgemiseks			
Ülevool	Katteplaadiga ülevool			
Segisti augud	aukudeta (4 x 35 mm altpoolt puuritud augud)			

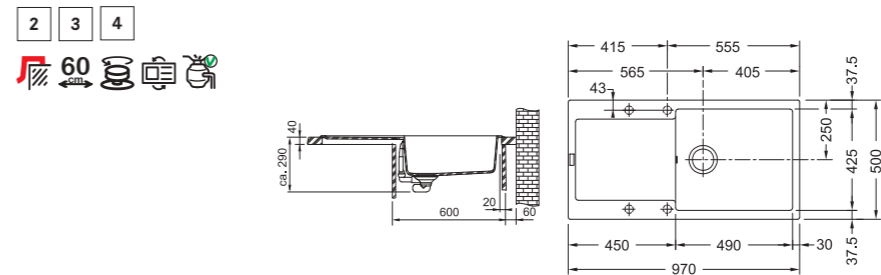



MARIS Fragranit valamud

Lisad

- | | | |
|---|---|---|
| <p>1 112.0066.060</p> <p>Roostevabast terasest nõrutuskauss plastkäepidemetega
156 x 417 x 54 mm
€ 91,50</p>  | <p>2 112.0075.642</p> <p>Rullmatt painduv
366 x 326 mm
€ 47,40</p>  | <p>3 112.0595.334</p> <p>Lõikelaud puit
532 x 280 mm
€ 39,60</p>  |
|---|---|---|



<p>Mudel MRG 611-78XL</p> <p>Aluskapp 60 cm</p> <p>Mõõdud 780 x 500 mm</p> <p>Väljalõige 760 x 480 mm (R=11 mm)</p> <p>Kausi mõõtmed 490 / 425 / 200 mm</p> <p>Paigaldamine Süvistatav</p> <p>Kausi asukoht Pööratav</p> <p>Materjal Fragranit+ / antibakteriaalne</p> <p>Ventiil Nupuga avatav 3/2" ventiil</p> <p>Ventiili juhtimine Ümar keeratav nupp sõela avamiseks või sulgemiseks</p> <p>Ülevool Katteplaadiga ülevool</p> <p>Segisti augud aukudeta (4 x 35 mm altpoolt puuritud augud)</p>	<p>Värv</p> <ul style="list-style-type: none"> polaarvalge cashmere kivihall grafiit onyx 	<p>Artikkel</p> <p>Hind €</p> <table border="0"> <tr><td>114.0479.022</td><td>317,00</td></tr> <tr><td>114.0479.027</td><td>317,00</td></tr> <tr><td>114.0479.030</td><td>317,00</td></tr> <tr><td>114.0479.031</td><td>317,00</td></tr> <tr><td>114.0479.032</td><td>317,00</td></tr> </table>	114.0479.022	317,00	114.0479.027	317,00	114.0479.030	317,00	114.0479.031	317,00	114.0479.032	317,00
114.0479.022	317,00											
114.0479.027	317,00											
114.0479.030	317,00											
114.0479.031	317,00											
114.0479.032	317,00											

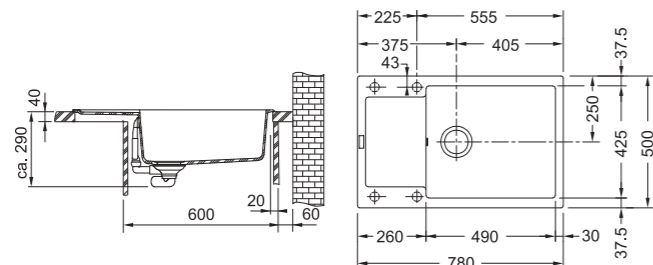

<p>Mudel MRG 611</p> <p>Aluskapp 45 cm</p> <p>Mõõdud 780 x 500 mm</p> <p>Väljalõige 760 x 480 mm (R=11 mm)</p> <p>Kausi mõõtmed 350 / 425 / 200 mm</p> <p>Paigaldamine Süvistatav</p> <p>Kausi asukoht Pööratav</p> <p>Materjal Fragranit+ / antibakteriaalne</p> <p>Ventiil Nupuga avatav 3/2" ventiil</p> <p>Ventiili juhtimine Ümar keeratav nupp sõela avamiseks või sulgemiseks</p> <p>Ülevool Katteplaadiga ülevool</p> <p>Segisti augud aukudeta (4 x 35 mm altpoolt puuritud augud)</p>	<p>Värv</p> <ul style="list-style-type: none"> polaarvalge cashmere kivihall grafiit onyx 	<p>Artikkel</p> <p>Hind €</p> <table border="0"> <tr><td>114.0055.697</td><td>317,00</td></tr> <tr><td>114.0302.705</td><td>317,00</td></tr> <tr><td>114.0055.695</td><td>317,00</td></tr> <tr><td>114.0055.693</td><td>317,00</td></tr> <tr><td>114.0176.603</td><td>317,00</td></tr> </table>	114.0055.697	317,00	114.0302.705	317,00	114.0055.695	317,00	114.0055.693	317,00	114.0176.603	317,00
114.0055.697	317,00											
114.0302.705	317,00											
114.0055.695	317,00											
114.0055.693	317,00											
114.0176.603	317,00											

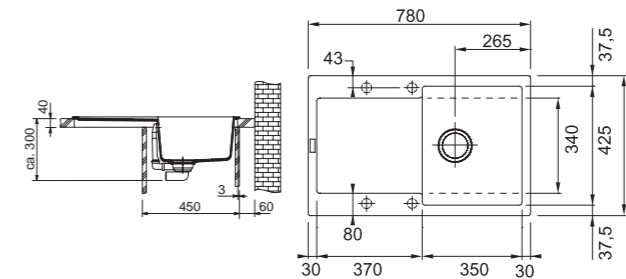
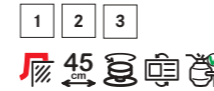

<p>Mudel MRG 611-62</p> <p>Aluskapp 45 cm</p> <p>Mõõdud 620 x 500 mm</p> <p>Väljalõige 600 x 480 mm (R=11 mm)</p> <p>Kausi mõõtmed 350 / 425 / 200 mm</p> <p>Paigaldamine Süvistatav</p> <p>Kausi asukoht Pööratav</p> <p>Materjal Fragranit+ / antibakteriaalne</p> <p>Ventiil Nupuga avatav 3/2" ventiil</p> <p>Ventiili juhtimine Ümar keeratav nupp sõela avamiseks või sulgemiseks</p> <p>Ülevool Katteplaadiga ülevool</p> <p>Segisti augud aukudeta (4 x 35 mm altpoolt puuritud augud)</p>	<p>Värv</p> <ul style="list-style-type: none"> polaarvalge cashmere kivihall grafiit onyx 	<p>Artikkel</p> <p>Hind €</p> <table border="0"> <tr><td>114.0253.323</td><td>290,00</td></tr> <tr><td>114.0302.708</td><td>290,00</td></tr> <tr><td>114.0253.324</td><td>290,00</td></tr> <tr><td>114.0253.319</td><td>290,00</td></tr> <tr><td>114.0253.322</td><td>290,00</td></tr> </table>	114.0253.323	290,00	114.0302.708	290,00	114.0253.324	290,00	114.0253.319	290,00	114.0253.322	290,00
114.0253.323	290,00											
114.0302.708	290,00											
114.0253.324	290,00											
114.0253.319	290,00											
114.0253.322	290,00											

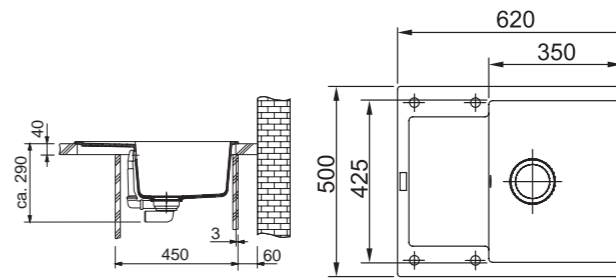
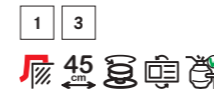



MARIS Fragranit valamud

Lisad

1 112.0066.060	2 112.0018.817	3 112.0017.900	4 112.0204.360
Roostevabast terasest nõrutuskauss plastkäepidemetega 156 x 417 x 54 mm € 91,50	Nõrutuskauss- roostevaba teras 160 x 405 mm € 39,20	Lõikelaud- klaas 280 x 408 mm € 39,20	Rv Mobiilne nõruti plastik raamis 326 x 440 x 23 mm € 101,90



Mudel **MRG 610-58**
 Aluskapp 60 cm
 Mõõdud 585 x 520 mm
 Väljalõige 565 x 500 mm (R=11 mm)
 Kausi mõõtmed 505 / 390 / 195 mm
 Paigaldamine Süvistatav
 Materjal Fragranit+ / antibakteriaalne
 Ventii Nupuga avatav 3½" ventii
 Ventii juhtimine Ümar keeratav nupp sõela avamiseks või sulgemiseks
 Ülevool Katteplaadiga ülevool
 Segisti augud aukudeta (3 x 35 mm altpoolt puuritud augud)

Värv	Artikkel	Hind €
	114.0079.802	280,00
	114.0302.697	280,00
	114.0083.247	280,00
	114.0075.390	280,00
	114.0176.610	280,00

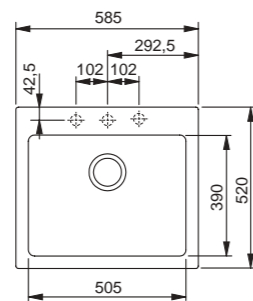
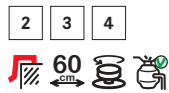

Mudel **MRG 610-42**
 Aluskapp 50 cm
 Mõõdud 425 x 520 mm
 Väljalõige 405 x 500 mm (R=11 mm)
 Kausi mõõtmed 345 / 390 / 195 mm
 Paigaldamine Süvistatav
 Materjal Fragranit+ / antibakteriaalne
 Ventii Nupuga avatav 3½" ventii
 Ventii juhtimine Ümar keeratav nupp sõela avamiseks või sulgemiseks
 Ülevool Katteplaadiga ülevool
 Segisti augud aukudeta (3 x 35 mm altpoolt puuritud augud)

Värv	Artikkel	Hind €
	114.0080.761	233,00
	114.0302.702	233,00
	114.0083.241	233,00
	114.0075.392	233,00
	114.0176.607	233,00

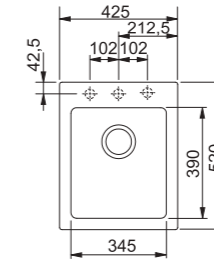
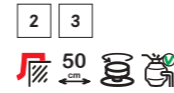

Mudel **MRG 620**
 Aluskapp 80 cm
 Mõõdud 800 x 520 mm
 Väljalõige 780 x 500 mm (R=11 mm)
 Kausi mõõtmed 2x 345 / 390 / 204 mm
 Paigaldamine Süvistatav
 Materjal Fragranit+ / antibakteriaalne
 Ventii Nupuga avatav 3½" ventii
 Ventii juhtimine Ümar keeratav nupp sõela avamiseks või sulgemiseks
 Ülevool Katteplaadiga ülevool
 Segisti augud aukudeta (4 x 35 mm altpoolt puuritud augud)

Värv	Artikkel	Hind €
	114.0176.587	409,00
	114.0302.711	409,00
	114.0176.585	409,00
	114.0176.584	409,00
	114.0176.591	409,00

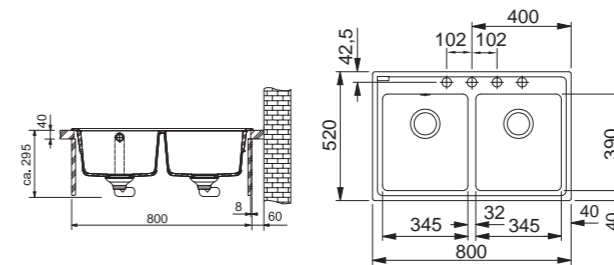
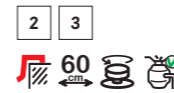

Mudel **MRG 612-E**
 Aluskapp 60 cm
 Mõõdud 960 x 500 mm
 Väljalõige Šablooni järgi
 Kausi mõõtmed 350 / 425 / 200 mm
 Paigaldamine Süvistatav
 Materjal Fragranit+ / antibakteriaalne
 Ventii Nupuga avatav 3½" ventii
 Ventii juhtimine Ümar keeratav nupp sõela avamiseks või sulgemiseks
 Ülevool Katteplaadiga ülevool
 Segisti augud aukudeta (2 x 35 mm altpoolt puuritud augud)

Värv	Artikkel	Hind €
	114.0197.774	401,00

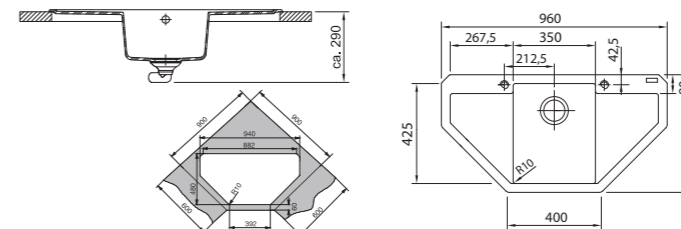



BASIS Fragranit valamud

Lisad

- | | |
|--|---|
| <p>1 112.0250.014</p> <p>Nõrutuskauss- roostevaba teras
160 x 300 x 70 mm
€ 40,90</p> | <p>2 112.0595.334</p> <p>Lõikelaud puit
532 x 280 mm
€ 39,60</p> |
|--|---|



Sisaldub komplektis

1 2



Mudel	BFG 651	Värv	Artikkel	Hind €
Aluskapp	60 cm		114.0256.626	316,00
Möödud	970 x 500 mm		114.0256.624	316,00
Väljalõige	950 x 480 mm (R=20 mm)		114.0301.961	316,00
Kausi mõõtmed	340 / 420 / 200 + 150 / 290 / 90 mm		114.0256.627	316,00
Paigaldamine	Süvistatav		114.0256.623	316,00
Kausi asukoht	Pööratav		114.0256.625	316,00
Materjal	Fragranit+ / antibakteriaalne			
Ventiil	Nupuga avatav 3½" ventiil			
Ventiili juhtimine	Ümar keeratav nupp sõela avamiseks või sulgemiseks			
Ventiil väikese kausi jaoks	Manuaalne 3½" ventiil			
Ülevool	Ümmargune ülevool			
Segisti augud	aukudeta (4 x 35 mm altpoolt puuritud augud)			
Sisaldub komplektis	Roostevabast terasest nõrutuskauss 112.0250.014			

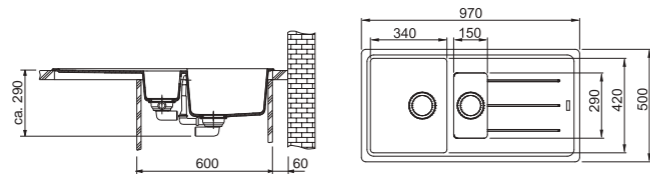

Sisaldub komplektis

1 2

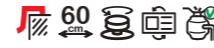

Mudel	BFG 651-78
Aluskapp	60 cm
Möödud	780 x 500 mm
Väljalõige	760 x 480 mm (R=20 mm)
Kausi mõõtmed	340 / 420 / 200 + 150 / 290 / 90 mm
Paigaldamine	Süvistatav
Kausi asukoht	Pööratav
Materjal	Fragranit+ / antibakteriaalne
Ventiil	Nupuga avatav 3½" ventiil
Ventiili juhtimine	Ümar keeratav nupp sõela avamiseks või sulgemiseks
Ventiil väikese kausi jaoks	Manuaalne 3½" ventiil
Ülevool	Ümmargune ülevool
Segisti augud	aukudeta (4 x 35 mm altpoolt puuritud augud)
Sisaldub komplektis	Roostevabast terasest nõrutuskauss 112.0250.014

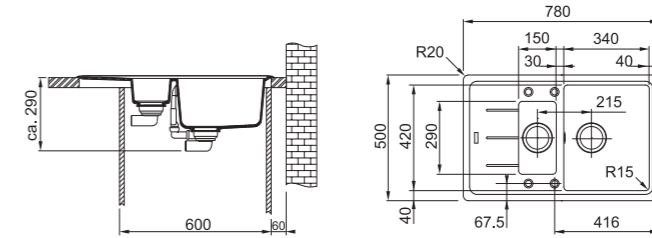

Värv	Artikkel	Hind €
	114.0301.368	287,00
	114.0301.370	287,00
	114.0301.951	287,00
	114.0301.367	287,00
	114.0301.361	287,00
	114.0301.345	287,00



2



Mudel	BFG 611-86
Aluskapp	45 cm
Möödud	860 x 500 mm
Väljalõige	840 x 480 mm (R=20 mm)
Kausi mõõtmed	340 / 420 / 200 mm
Paigaldamine	Süvistatav
Kausi asukoht	Pööratav
Materjal	Fragranit+ / antibakteriaalne
Ventiil	Nupuga avatav 3½" ventiil
Ventiili juhtimine	Ümar keeratav nupp sõela avamiseks või sulgemiseks
Ülevool	Ümmargune ülevool
Segisti augud	aukudeta (2 x 35 mm altpoolt puuritud augud)

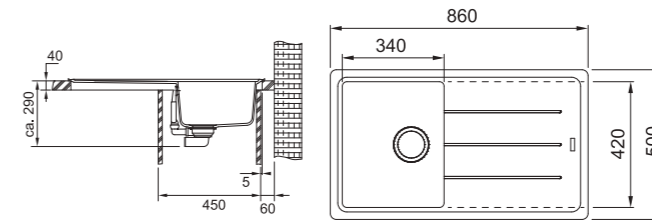

Värv	Artikkel	Hind €
	114.0336.417	256,00
	114.0336.914	256,00
	114.0336.916	256,00
	114.0336.936	256,00
	114.0336.938	256,00
	114.0336.939	256,00





BASIS Fragranit valamud

1 112.0595.334

Lõikelaud puit
532 x 280 mm
€ 39,60



Mudel **BFG 611**
Aluskapp 45 cm
Mõõdud 780 x 500 mm
Väljalõige 760 x 480 mm (R=20 mm)
Kausi mõõtmed 340 / 420 / 200 mm
Paigaldamine Süvistatav
Kausi asukoht Pööratav
Materjal Fragranit+ / antibakteriaalne
Ventil Nupuga avatav 3½" ventiil
Ventili juhtimine Ümar keeratav nupp sõela avamiseks või sulgemiseks
Ülevool Ümmargune ülevool
Segisti augud aukudeta (2 x 35 mm altpoolt puuritud augud)

Värv	Artikkel	Hind €
	114.0256.611	244,00
	114.0256.609	244,00
	114.0301.907	244,00
	114.0256.612	244,00
	114.0256.604	244,00
	114.0256.610	244,00

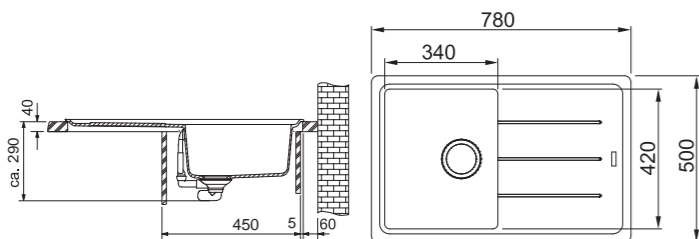

Mudel **BFG 611-62**
Aluskapp 45 cm
Mõõdud 620 x 500 mm
Väljalõige 600 x 480 mm (R=20 mm)
Kausi mõõtmed 340 / 420 / 200 mm
Paigaldamine Süvistatav
Kausi asukoht Pööratav
Materjal Fragranit+ / antibakteriaalne
Ventil Nupuga avatav 3½" ventiil
Ventili juhtimine Ümar keeratav nupp sõela avamiseks või sulgemiseks
Ülevool Ümmargune ülevool
Segisti augud aukudeta (4 x 35 mm altpoolt puuritud augud)

Värv	Artikkel	Hind €
	114.0301.335	232,00
	114.0301.342	232,00
	114.0301.903	232,00
	114.0301.333	232,00
	114.0301.332	232,00
	114.0301.331	232,00

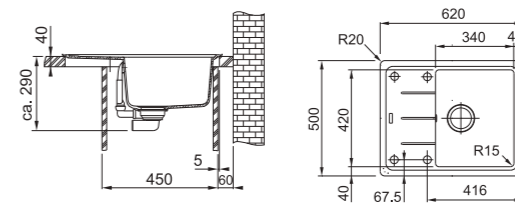

Mudel **BFG 620**
Aluskapp 80 cm
Mõõdud 860 x 500 mm
Väljalõige 840 x 480 mm (R=20 mm)
Kausi mõõtmed 2x 337 / 420 / 200 mm
Paigaldamine Süvistatav
Materjal Fragranit+ / antibakteriaalne
Ventil Nupuga avatav 3½" ventiil
Ventili juhtimine Ümar keeratav nupp sõela avamiseks või sulgemiseks
Ülevool Ümmargune ülevool
Segisti augud aukudeta (2 x 35 mm altpoolt puuritud augud)

Värv	Artikkel	Hind €
	114.0302.016	325,00
	114.0302.018	325,00
	114.0302.021	325,00
	114.0302.015	325,00
	114.0301.998	325,00
	114.0301.373	325,00

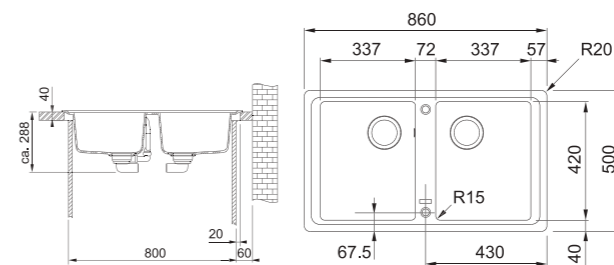



URBAN Fragranit valamud

Lisad

- | | | |
|---|--------------|--|
| 1 | 112.0538.950 | Plastikust nõrutuskauss hall
440 x 181 x 92 mm
€ 17,30 |
| 2 | 112.0066.060 | Roostevabast terasest nõrutus-
kauss plastkäepidemetega
156 x 417 x 54 mm
€ 91,50 |
| 3 | 112.0566.182 | Plastikust nõrutuskauss hall
€ 13,10 |
| 4 | 112.0595.334 | Lõikelaud puit
532 x 280 mm
€ 39,60 |



Sisaldub komplektis

Sisaldub komplektis

Mudel **UBG 651-100**
 Aluskapp 60 cm
 Mõõdud 1000 x 500 mm
 Väljalõige 964 x 464 mm (R=15mm)
 Kausi mõõtmed 350 / 425 / 220 x 166 / 322 / 80 mm
 Paigaldamine Tasapinnaline või sülvestatav (FastFix)
 Kausi asukoht Pööratav
 Materjal Fragranit+ / antibakteriaalne
 Ventil Nupuga avatav 3½" ventiil
 Ventili juhtimine Ümar keeratav nupp sõela avamiseks või sulgemiseks
 Ventil väikese kausi jaoks Manuaalne 3½" ventiil
 Ülevool Katteplaadiga ülevool
 Segisti augud aukudeta (2 x 35 mm altpoolt puuritud augud)
 Sisaldub komplektis Plastik nõrutuskauss 112.0538.950
 Plastik nõrutuskauss 112.0566.182
 Tööpinda süvistamiseks min. 12 mm
 Tööpinna tasapinnaline kinnitus min. 20 mm

Värv	Artikkel	Hind €
	114.0593.173	339,00
	114.0593.175	339,00
	114.0593.172	339,00
	114.0593.171	339,00
	114.0593.130	339,00

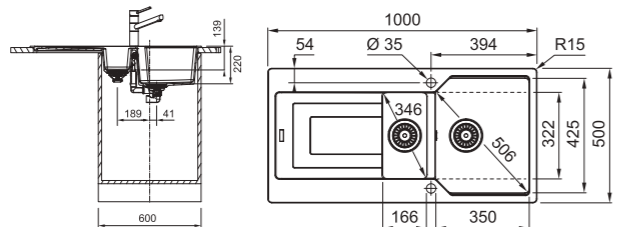

Augufrees 35mm Fragranit ja Tectonite valamutele
 Art.Nr 112.0473.656 € 3,90



Sisaldub komplektis



Mudel **UBG 611-100**
 Aluskapp 60 cm
 Mõõdud 1000 x 500 mm
 Väljalõige 964 x 464 mm (R=15mm)
 Kausi mõõtmed 488 / 428 / 220 mm
 Paigaldamine Tasapinnaline või sülvestatav (FastFix)
 Kausi asukoht Pööratav
 Materjal Fragranit+ / antibakteriaalne
 Ventil Nupuga avatav 3½" ventiil
 Ventili juhtimine Ümar keeratav nupp sõela avamiseks või sulgemiseks
 Ülevool Katteplaadiga ülevool
 Segisti augud aukudeta (2 x 35 mm altpoolt puuritud augud)
 Sisaldub komplektis Plastik nõrutuskauss 112.0538.950
 Tööpinda süvistamiseks min. 12 mm
 Tööpinna tasapinnaline kinnitus min. 20 mm

Värv	Artikkel	Hind €
	114.0556.574	302,00
	114.0556.573	302,00
	114.0556.575	302,00
	114.0556.500	302,00
	114.0556.572	302,00

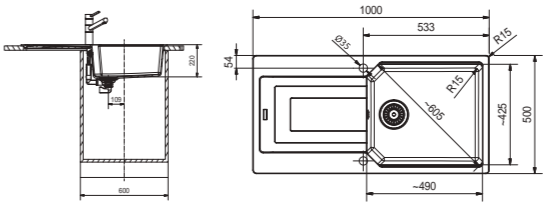

Sisaldub komplektis

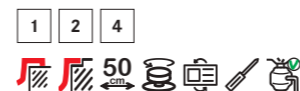

Mudel **UBG 611-86**
 Aluskapp 50 cm
 Mõõdud 860 x 500 mm
 Väljalõige 824 x 464 mm (R=15mm)
 Kausi mõõtmed 390 / 425 / 220 mm
 Paigaldamine Tasapinnaline või sülvestatav (FastFix)
 Kausi asukoht Pööratav
 Materjal Fragranit+ / antibakteriaalne
 Ventil Nupuga avatav 3½" ventiil
 Ventili juhtimine Ümar keeratav nupp sõela avamiseks või sulgemiseks
 Ülevool Katteplaadiga ülevool
 Segisti augud aukudeta (2 x 35 mm altpoolt puuritud augud)
 Sisaldub komplektis Plastik nõrutuskauss 112.0538.950
 Tööpinda süvistamiseks min. 12 mm
 Tööpinna tasapinnaline kinnitus min. 20 mm

Värv	Artikkel	Hind €
	114.0556.614	280,00
	114.0556.613	280,00
	114.0556.615	280,00
	114.0556.600	280,00
	114.0556.612	280,00

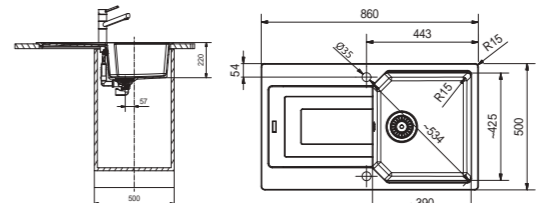

Sisaldub komplektis



Mudel **UBG 611-78**
 Aluskapp 45 cm
 Mõõdud 780 x 500 mm
 Väljalõige 744 x 464 mm (R=15mm)
 Kausi mõõtmed 350 / 425 / 220 mm
 Paigaldamine Tasapinnaline või sülvestatav (FastFix)
 Kausi asukoht Pööratav
 Materjal Fragranit+ / antibakteriaalne
 Ventil Nupuga avatav 3½" ventiil
 Ventili juhtimine Ümar keeratav nupp sõela avamiseks või sulgemiseks
 Ülevool Katteplaadiga ülevool
 Segisti augud aukudeta (2 x 35 mm altpoolt puuritud augud)
 Sisaldub komplektis Plastik nõrutuskauss 112.0538.950
 Tööpinda süvistamiseks min. 12 mm
 Tööpinna tasapinnaline kinnitus min. 20 mm

Värv	Artikkel	Hind €
	114.0556.594	259,00
	114.0556.593	259,00
	114.0556.595	259,00
	114.0556.590	259,00
	114.0556.592	259,00

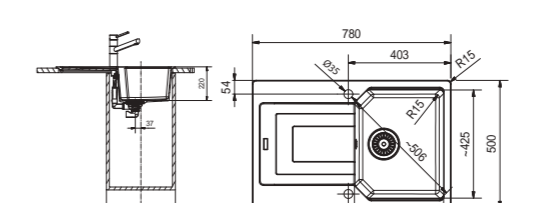



URBAN Fragranit valamud

Lisad

- | | | |
|--|---|---|
| <p>1 112.0538.950</p> <p>Plastikust nõrutuskauss hall
440 x 181 x 92 mm
€ 17,30</p>  | <p>2 112.0066.060</p> <p>Roostevabast terasest nõrutuskauss plastkäepidemetega
156 x 417 x 54 mm
€ 91,50</p>  | <p>3 112.0595.334</p> <p>Lõikelaud puit
532 x 280 mm
€ 39,60</p>  |
|--|---|---|



Sisaldub komplektis



Mudel	Aluskapp	Mõõdud	Väljalõige	Kausi mõõtmed	Paigaldamine	Kausi asukoht	Materjal	Ventii	Ventii juhtimine	Ülevool	Segisti augud	Sisaldub komplektis	Tööpinda süvistamiseks	Tööpinna tasapinnaline kinnitus
UBG 611-78XL	60 cm	780 x 500 mm	744 x 464 mm (R=15mm)	491 / 425 / 220 mm	Tasapinnaline või süvistatav (FastFix)	Pööratav	Fragranit+ / antibakteriaalne	Nupuga avatav 3/2" ventii	Ümar keeratav nupp sõela avamiseks või sulgemiseks	Katteplaadiga ülevool	aukudeta (2 x 35 mm altpoolt puuritud aukud)	Plastist nõrutuskauss 112.0538.950	min. 12 mm	min. 20 mm

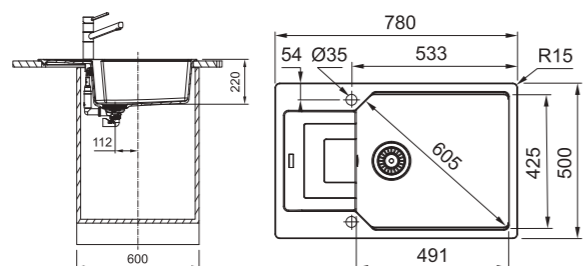

Augufrees 35mm Fragranit ja Tectonite valamutele
Art.Nr 112.0473.656 € 3,90



Sisaldub komplektis



Mudel	Aluskapp	Mõõdud	Väljalõige	Kausi mõõtmed	Paigaldamine	Kausi asukoht	Materjal	Ventii	Ventii juhtimine	Ülevool	Segisti augud	Sisaldub komplektis	Tööpinda süvistamiseks	Tööpinna tasapinnaline kinnitus
UBG 611-62	45 cm	620 x 500 mm	584 x 464 mm (R=15mm)	350 / 425 / 220 mm	Tasapinnaline või süvistatav (FastFix)	Pööratav	Fragranit+ / antibakteriaalne	Nupuga avatav 3/2" ventii	Ümar keeratav nupp sõela avamiseks või sulgemiseks	Katteplaadiga ülevool	aukudeta (2 x 35 mm altpoolt puuritud aukud)	Plastist nõrutuskauss 112.0538.950	min. 12 mm	min. 20 mm

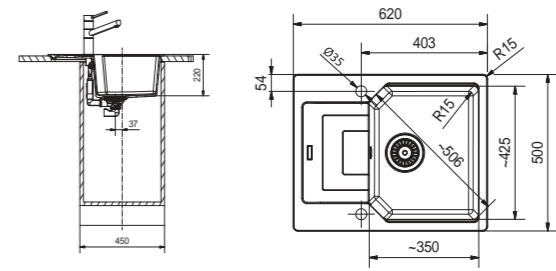

Sisaldub komplektis



Mudel	Aluskapp	Mõõdud	Väljalõige	Kausi mõõtmed	Paigaldamine	Kausi asukoht	Materjal	Ventii	Ventii juhtimine	Ülevool	Segisti augud	Sisaldub komplektis	Tööpind iegriež. vers.	Tööpinna tasapinnaline kinnitus
UBG 610-56	60 cm	560 x 500 mm	524 x 464 mm (R=15mm)	503 / 425(374) / 220 mm	Tasapinnaline või süvistatav (FastFix)	Pööratav	Fragranit+ / antibakteriaalne	Nupuga avatav 3/2" ventii	Ümar keeratav nupp sõela avamiseks või sulgemiseks	Katteplaadiga ülevool	aukudeta (2 x 35 mm altpoolt puuritud aukud)	Plastist nõrutuskauss 112.0538.950	min. 12 mm	min. 20 mm

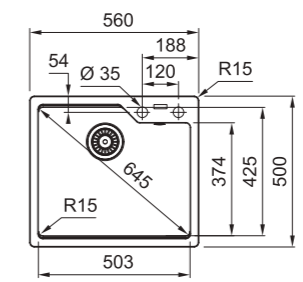



CENTRO Fragranit valamud

Lisad

1 112.0595.334

Lõikelaud puit
532 x 280 mm
€ 39,60



Mudel **CNG 611-86**
Aluskapp 50 cm
Mõõdud 860 x 500 mm
Väljalõige 826 x 466 mm (R=15mm)
Kausi mõõtmed 392 / 435 / 200 mm
Paigaldamine Tasapinnaline või sülvestatav (FastFix)
Kausi asukoht Pööratav
Materjal Fragranit+ / antibakteriaalne
Ventii Nupuga avatav 3/2" ventii
Ventii juhtimine Ümar keeratav nupp sõela avamiseks või sulgemiseks
Ülevool Katteplaadiga ülevool
Segisti augud aukudeta (2 x 35 mm altpoolt puuritud augud)

Värv	Artikkel	Hind €
	114.0625.644	305,00
	114.0625.645	305,00
	114.0625.643	305,00
	114.0625.641	305,00
	114.0625.632	305,00

Tööpinda sülvestamiseks min. 12 mm
Tööpinna tasapinnaline kinnitus min. 20 mm

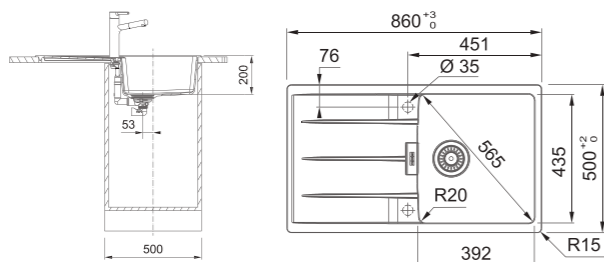

Mudel **CNG 611-78**
Aluskapp 45 cm
Mõõdud 780 x 500 mm
Väljalõige 746 x 466 mm (R=15mm)
Kausi mõõtmed 342 / 435 / 200 mm
Paigaldamine Tasapinnaline või sülvestatav (FastFix)
Kausi asukoht Pööratav
Materjal Fragranit+ / antibakteriaalne
Ventii Nupuga avatav 3/2" ventii
Ventii juhtimine Ümar keeratav nupp sõela avamiseks või sulgemiseks
Ülevool Katteplaadiga ülevool
Segisti augud aukudeta (2 x 35 mm altpoolt puuritud augud)

Värv	Artikkel	Hind €
	114.0625.630	282,00
	114.0625.631	282,00
	114.0625.629	282,00
	114.0625.627	282,00
	114.0625.626	282,00

UUDIS



Tööpinda sülvestamiseks min. 12 mm
Tööpinna tasapinnaline kinnitus min. 20 mm

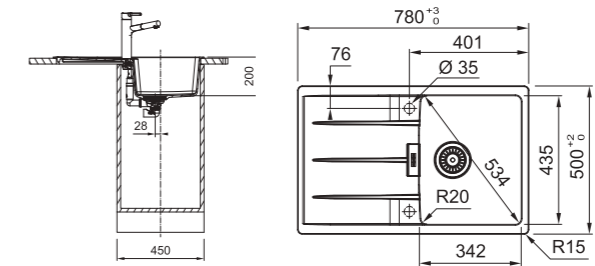

Mudel **CNG 611-62**
Aluskapp 45 cm
Mõõdud 620 x 500 mm
Väljalõige 586 x 466 mm (R=15mm)
Kausi mõõtmed 342 / 435 / 200 mm
Paigaldamine Tasapinnaline või sülvestatav (FastFix)
Kausi asukoht Pööratav
Materjal Fragranit+ / antibakteriaalne
Ventii Nupuga avatav 3/2" ventii
Ventii juhtimine Ümar keeratav nupp sõela avamiseks või sulgemiseks
Ülevool Katteplaadiga ülevool
Segisti augud aukudeta (2 x 35 mm altpoolt puuritud augud)

Värv	Artikkel	Hind €
	114.0625.624	259,00
	114.0625.625	259,00
	114.0625.623	259,00
	114.0625.621	259,00
	114.0625.620	259,00

UUDIS



Tööpinda sülvestamiseks min. 12 mm
Tööpinna tasapinnaline kinnitus min. 20 mm

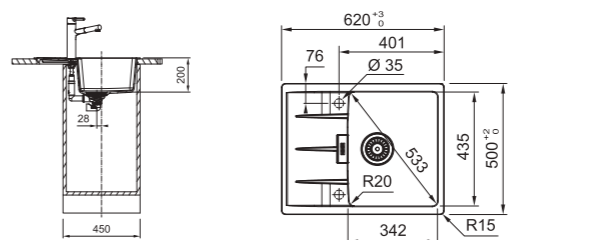



CENTRO Fragranit valamud

Lisad

1 112.0595.334

Lõikelaud puit
532 x 280 mm
€ 39,60



Mudel **CNG 610-54**
Aluskapp **60 cm**
Mõõdud **590 x 500 mm**
Väljalõige **570 x 480 mm (R=15mm)**
Kausi mõõtmed **540 /400 /200 mm**
Paigaldamine **Tasapinnaline või sivistatav (FastFix)**
Kausi asukoht **Pööratav**
Materjal **Fragranit+ / antibakteriaalne**
Ventiiil **Nupuga avatav 3½" ventiil**
Ventiiili juhtimine **Ümar keeratav nupp sõela avamiseks või sulgemiseks**
Ülevool **Katteplaadiga ülevool**
Segisti augud **aukudeta (5 x 35 mm altpoolt puuritud augud)**
Tööpinda sivistamiseks **min. 12 mm**
Tööpinna tasapinnaline kinnitus **min. 20 mm**

Värv	Artikkel	Hind €
 kivihall	114.0627.677	270,00
 onyx	114.0627.660	270,00
 must matt	114.0627.654	270,00

UUDIS

1

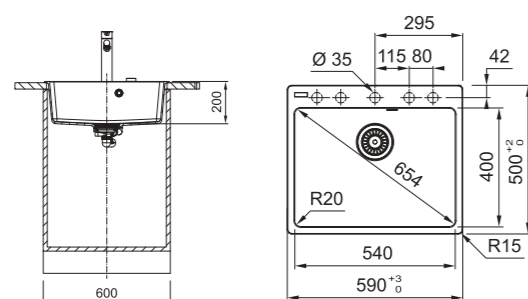

Augufrees 35mm Fragranit ja Tectonite valamutele
Art.Nr 112.0473.656 € 3,90



Mudel **CNG 610-39**
Aluskapp **45 cm**
Mõõdud **440 x 500 mm**
Väljalõige **420 x 480 mm (R=15mm)**
Kausi mõõtmed **390 /400 /200 mm**
Paigaldamine **Tasapinnaline või sivistatav (FastFix)**
Kausi asukoht **Pööratav**
Materjal **Fragranit+ / antibakteriaalne**
Ventiiil **Nupuga avatav 3½" ventiil**
Ventiiili juhtimine **Ümar keeratav nupp sõela avamiseks või sulgemiseks**
Ülevool **Katteplaadiga ülevool**
Segisti augud **aukudeta (3 x 35 mm altpoolt puuritud augud)**
Tööpinda sivistamiseks **min. 12 mm**
Tööpinna tasapinnaline kinnitus **min. 20 mm**

Värv	Artikkel	Hind €
 kivihall	114.0627.676	224,00
 onyx	114.0627.659	224,00
 must matt	114.0627.652	224,00

UUDIS

1

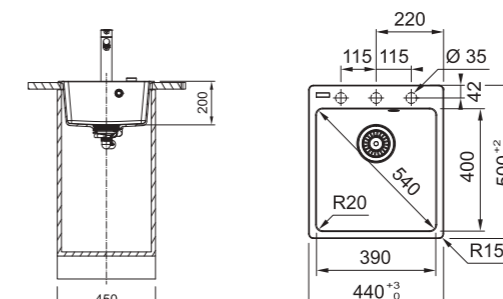



RONDA Fragranit valamud



Mudel **ROG 611**
 Aluskapp 45 cm
 Mõõdud 770 x 500 mm
 Väljalõige Šablooni järgi
 Kausi mõõtmed Ø 410 / 195 mm
 Paigaldamine Süvistatav
 Kausi asukoht Pööratav
 Materjal Fragranit+ / antibakteriaalne
 Ventii Nupuga või käsitsi avatav ventiil
 Ventii juhtimine Nupuga või käsitsi
 Ülevool Ümmargune ülevool
 Segisti augud aukudeta (2 x 35 mm altpoolt puuritud augud)

Värv	Artikkel	Hind €
Ventii 3½" nupuga	114.0031.171	245,00
Ventii 3½" nupuga	114.0031.168	245,00
Manuaalne 3½" ventiil	114.0029.528	234,00
Manuaalne 3½" ventiil	114.0029.525	234,00

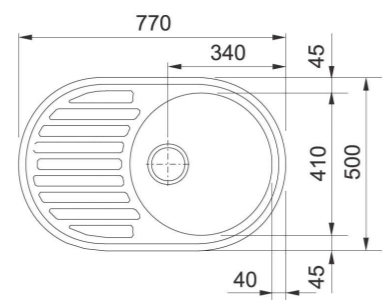

Mudel **ROG 611-62**
 Aluskapp 45 cm
 Mõõdud 620 x 500 mm
 Väljalõige Šablooni järgi
 Kausi mõõtmed Ø 410 / 195 mm
 Paigaldamine Süvistatav
 Kausi asukoht Pööratav
 Materjal Fragranit+ / antibakteriaalne
 Ventii Manuaalne
 Ventii juhtimine Põhjasõela käsitsi avamine
 Ülevool Ümmargune ülevool
 Segisti augud aukudeta (2 x 35 mm altpoolt puuritud augud)

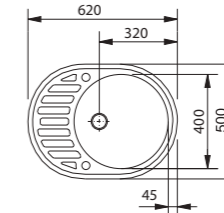

Värv	Artikkel	Hind €
Ventii 3½" nupuga	114.0316.528	201,00
Ventii 3½" nupuga	114.0316.526	201,00

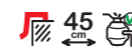

Mudel **ROG 610-41**
 Aluskapp 45 cm
 Mõõdud Ø 510 mm
 Väljalõige Ø 493 mm
 Kausi mõõtmed Ø 400 / 195 mm
 Paigaldamine Süvistatav
 Materjal Fragranit+ / antibakteriaalne
 Ventii Nupuga või käsitsi avatav ventiil
 Ventii juhtimine Nupuga või käsitsi
 Ülevool Ümmargune ülevool
 Segisti augud 35 mm auk + augu jaoks eelnevalt puuritud koht

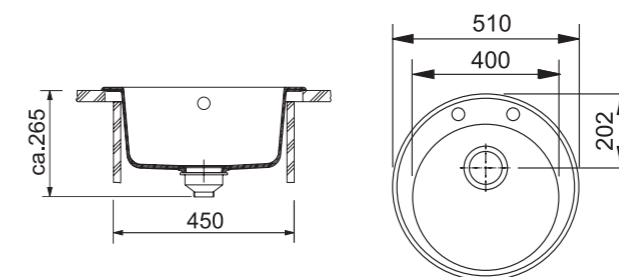

Värv	Artikkel	Hind €
Ventii 3½" nupuga	114.0009.509	185,00
Ventii 3½" nupuga	114.0009.506	185,00
Ventii 3½" nupuga	114.0009.505	185,00
Ventii 3½" nupuga	114.0009.513	185,00
Ventii 3½" nupuga	114.0199.717	185,00

Värv	Artikkel	Hind €
Manuaalne 3½" ventiil	114.0009.546	169,00
Manuaalne 3½" ventiil	114.0009.543	169,00
Manuaalne 3½" ventiil	114.0009.542	169,00
Manuaalne 3½" ventiil	114.0009.550	169,00
Manuaalne 3½" ventiil	114.0199.718	169,00



Augufrees 35mm Fragranit ja Tectonite valamutele
 Art.Nr 112.0473.656 € 3,90



STRATA Fragranit valamud



Mudel **STG 614**
 Aluskapp 45 cm
 Mõõdud 860 x 435 mm
 Väljalõige 840 x 415 mm (R= 20 mm)
 Kausi mõõtmed 333 /360 /165 mm
 Paigaldamine Süvistatav
 Kausi asukoht Pööratav
 Materjal Fragranit+ / antibakteriaalne
 Ventii Manuaalne
 Ventii juhtimine Põhjasõela käsitsi avamine
 Ülevool Peal katteplaadiga
 Segisti augud aukudeta (2 x 35 mm altpoolt puuritud augud)

Värv	Artikkel	Hind €
polaarvalge	114.0302.760	211,00
beež	114.0302.757	211,00
kivihall	114.0197.797	211,00
grafiit	114.0197.796	211,00
onyx	114.0302.751	211,00

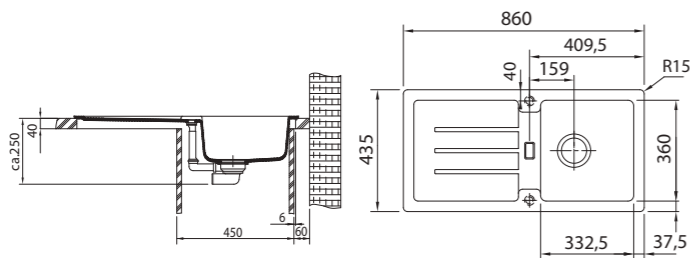

Mudel **STG 614-78**
 Aluskapp 45 cm
 Mõõdud 780 x 435 mm
 Väljalõige 760 x 415 mm (R= 20 mm)
 Kausi mõõtmed 333 /360 /165 mm
 Paigaldamine Süvistatav
 Kausi asukoht Pööratav
 Materjal Fragranit+ / antibakteriaalne
 Ventii Manuaalne
 Ventii juhtimine Põhjasõela käsitsi avamine
 Ülevool Peal katteplaadiga
 Segisti augud aukudeta (2 x 35 mm altpoolt puuritud augud)

Värv	Artikkel	Hind €
polaarvalge	114.0303.670	202,00
beež	114.0303.672	202,00
kivihall	114.0303.671	202,00
grafiit	114.0303.669	202,00
onyx	114.0303.666	202,00

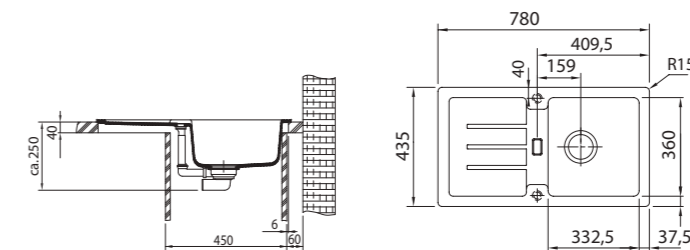

TECTONITE VALAMUD



- ① Tarvikud, mis muudavad valamud kasutamise veelgi lihtsamaks, kuna saate seda kõike ühes kohas teha.



- ② Kaetud ülevool on paigutatud võimalikult kõrgele ja seda on lihtne puhastada.



- ③ Suur ja tasane nõrutuspind eemaldab liigse vee



- ④ Sügav kauss, mis võimaldab teil pesta isegi suuri potte või plaate ja hoida kõik puhtana.



- ⑤ Fast Fix süsteem muudab valamud paigaldamise väga kiireks ja ilma täiendavate tööriistadeta.



- ⑥ Segisti stabiilne koht, võimaldades isegi väga suure segisti paigaldamist.



MIS TECTONITE®?

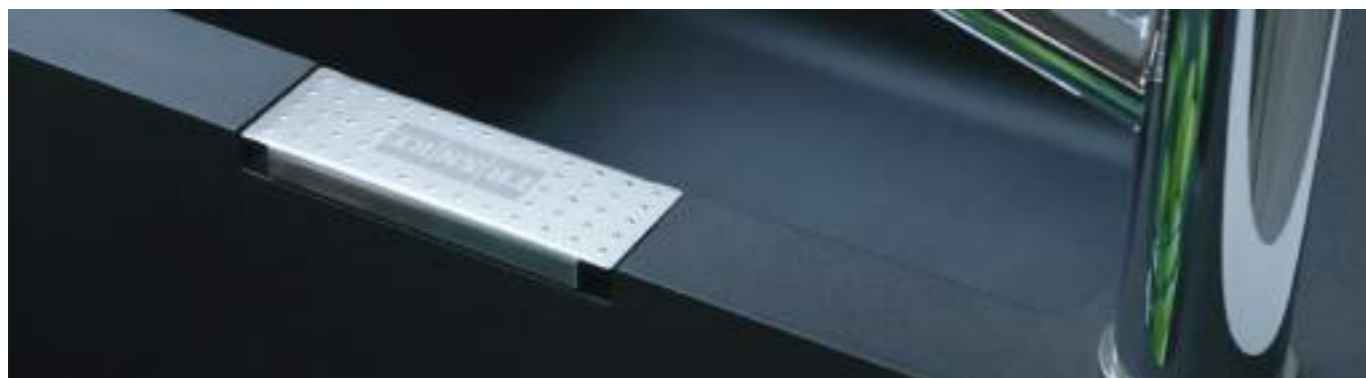

Tectonite® on Franke innovatiivne ja patenteeritud sünteetiline materjal. See annab valamule suurepärase kasutusmugavuse ja väljanägemise. FRANKE on ainus tootja, kes on välja töötanud ja patenteerinud uue põlvkonna materjali Tectonite®. Meil on eksklusiivne oskusteave, pidevalt teeme uuringuid ning parandame uute tootmistehnoloogiate abil materjale.



TECTONITE® VALAMU EELISED



Kõrge temperatuuritaluvus. 10-15 sek. talub isegi 300°C temperatuuri.

Tavaliselt ahju temperatuur ei ületa 230° C. Valamud Tectonite® materjalist ei karda üldjuhul isegi kuuma potti.



Vastupidavus plekkidele

Tänu moodsale tootmistehnoloogiale Tectonite® materjal on vastupidav määrivatele ainetele ja neid saab pesta jäljetult isegi pärast 24 tundi.



Löögikindel

Materjal on vastupidav mitmesuguste õnnetuste suhtes, mis võivad köögis juhtuda. Katsed on tõestanud, et valamud ei lähe katki, kui kööginõud selle peale kukuvad.



Kaitse UV-kiirguse vastu

Tectonite® materjal on vastupidav ultraviolettkiirgusele ja seetõttu valamud ei kaota oma esialgset värvi.



Kriimustus- ja kraapimiskindel

Valamud on kaetud väikeste klaasist osakestega. Uus Tectonite® valamud pakub suuremat vastupanu kriimustustele ja kraapimistele. Kulumiskindlus ületab tublisti turul olevaid komposiitmaterjale.



Kaasaegne materjal

Matt kate ja ainulaadsed värvid annavad Franke valamule uue ilme, mis sobib kaasaegse köögi interjööri suundumustega.



Sile ja lihtne puhastada

Tänu eriti siledale katile, mis kaitseb valamud plekkide eest, FRANKE Tectonite® tooted on hügieenilised ja kergesti puhastatavad.



Lihtne paigaldada

Tectonite® ei ole mitte ainult väga vastupidav, vaid ka kerge, mis märgatavalt kergendab transporti ja lihtsustab valamud paigaldamist.

Tectonite valamud aluskapi laiuse järgi

60 cm



Sirius
S2D 651
1000 x 500 mm
78. lk.



Sirius
S2D 611-100
1000 x 500 mm
79. lk.



Sirius
S2D 611-78XL
780 x 500 mm
79. lk.



Sirius
SID 610
560 x 530 mm
80. lk.

50 cm



Sirius
S2D 611-78
780 x 500 mm
79. lk.

45 cm



Sirius
S2D 611-62
620 x 500 mm
80. lk.



Sirius
SID 610-40
430 x 530 mm
81. lk.



Single
SINGLE
Ø500 mm
81. lk.

TECTONITE värvid



Arktis weiss



Cafe creme



Urban grey



Carbon



SIRIUS Tectonite valamud

Lisad

- | | |
|--|---|
| <p>1 112.05.12.280</p> <p>Plastikust nõrutuskass hall
456 x 179 x 92 mm
€ 20,00</p> | <p>2 112.0595.334</p> <p>Lõikelaud puit
532 x 280 mm
€ 40,00</p> |
|--|---|



Mudel **S2D 651**
 Aluskapp 60 cm
 Mõõdud 1000 x 500 mm
 Väljalõige 984 x 484 mm (R = 7,5 mm)
 Kausi mõõtmed 350 / 432 / 200 + 150 / 350 / 150 mm
 Paigaldamine Suvistatav
 Kausi asukoht Pööratav
 Materjal Tectonite
 Ventii Manuaalne 3 1/2" ventii
 Ventii juhtimine Käsitsi avamine / sulgemine
 Ülevool kaetud roosteabast terasest plaadiga
 Segisti augud ilma segisti aukudeta
 Kinnitussüsteem FastFix süsteem

Värv	Artikkel	Hind €
	143.06.15.781	185,00
	143.06.15.630	185,00
	143.06.15.785	185,00
	143.06.15.629	185,00

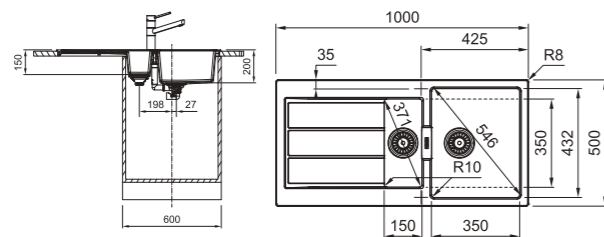

Mudel **S2D 611-100**
 Aluskapp 60 cm
 Mõõdud 1000 x 500 mm
 Väljalõige 984 x 484 mm (R = 7,5 mm)
 Kausi mõõtmed 450 / 432 / 200 mm
 Paigaldamine Suvistatav
 Kausi asukoht Pööratav
 Materjal Tectonite
 Ventii Manuaalne 3 1/2" ventii
 Ventii juhtimine Käsitsi avamine / sulgemine
 Ülevool kaetud roosteabast terasest plaadiga
 Segisti augud ilma segisti aukudeta
 Kinnitussüsteem FastFix süsteem

Värv	Artikkel	Hind €
	143.0590.205	156,00
	143.0590.211	156,00
	143.0590.207	156,00
	143.0590.212	156,00

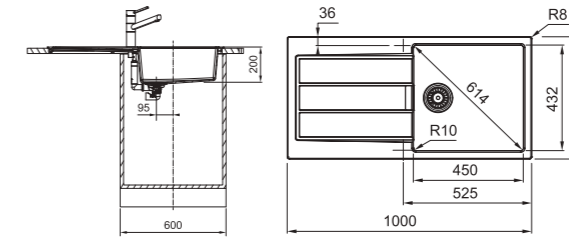
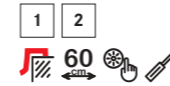

Mudel **S2D 611-78**
 Aluskapp 50 cm
 Mõõdud 780 x 500 mm
 Väljalõige 764 x 484 mm (R = 7,5 mm)
 Kausi mõõtmed 350 / 432 / 200 mm
 Paigaldamine Suvistatav
 Kausi asukoht Pööratav
 Materjal Tectonite
 Ventii Manuaalne
 Ventii juhtimine Põhjasõela käsitsi avamine
 Ülevool kaetud roosteabast terasest plaadiga
 Segisti augud ilma segisti aukudeta
 Kinnitussüsteem FastFix süsteem

Värv	Artikkel	Hind €
	143.0590.159	143,00
	143.0590.195	143,00
	143.0590.191	143,00
	143.0590.196	143,00

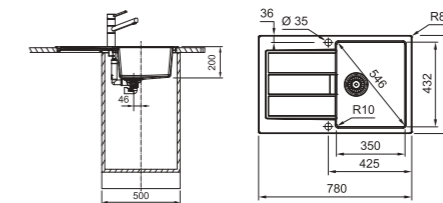
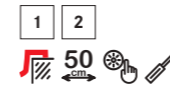

Mudel **S2D 611-78XL**
 Aluskapp 60 cm
 Mõõdud 780 x 500 mm
 Väljalõige 764 x 484 mm (R = 7,5 mm)
 Kausi mõõtmed 440 / 432 / 200 mm
 Paigaldamine Suvistatav
 Kausi asukoht Pööratav
 Materjal Tectonite
 Ventii Manuaalne
 Ventii juhtimine Käsitsi
 Ülevool kaetud roosteabast terasest plaadiga
 Segisti augud ilma segisti aukudeta
 Kinnitussüsteem FastFix süsteem

Värv	Artikkel	Hind €
	143.0590.221	150,00
	143.0590.227	150,00
	143.0590.223	150,00
	143.0590.228	150,00

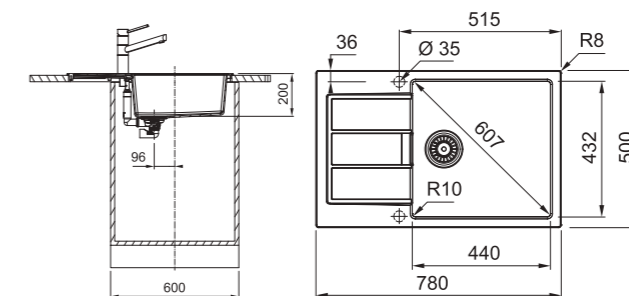
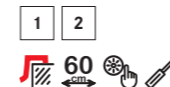



SIRIUS Tectonite valamud

Lisad

1 112.05.12.280
Plastikust nõrutuskauss hall
456 x 179 x 92 mm
€ 19,20



2 112.0595.334
Lõikelaud puit
532 x 280 mm
€ 39,60



Mudel **S2D 611-62**
Aluskapp 45 cm
Mõõdud 620 x 500 mm
Väljalõige 604 x 484 mm (R = 7,5 mm)
Kausi mõõtmed 343 / 432 / 200 mm
Paigaldamine Süstistatav
Kausi asukoht Pööratav
Materjal Tectonite
Ventil Manuaalne 3 1/2" ventiil
Ventili juhtimine Käsitsi avamine / sulgemine
Ülevool kaetud roosteabast terasest plaadiga
Segisti augud ilma segisti aukudeta
Kinnitussüsteem FastFix süsteem

Värv	Artikkel	Hind €
Arktis weiss	143.06.16.341	136,00
Cafe creme	143.06.16.340	136,00
Urban grey	143.06.16.345	136,00
Carbon	143.06.16.339	136,00

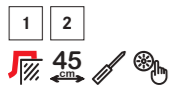
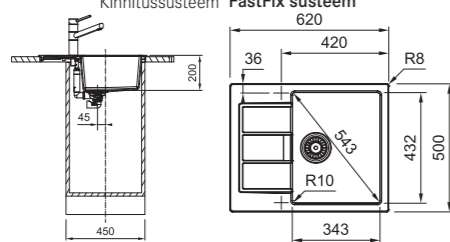

Mudel **SID 610**
Aluskapp 60 cm
Mõõdud 560 x 530 mm
Väljalõige 540 x 510 mm
Kausi mõõtmed 490 / 370 / 200 mm
Paigaldamine Süstistatav
Materjal Tectonite
Ventil Manuaalne 3 1/2" ventiil
Ventili juhtimine Käsitsi avamine / sulgemine
Ülevool Ümmargune ülevool
Segisti augud Segisti jaoks 35 mm auk

Värv	Artikkel	Hind €
Arktis weiss	114.0368.449	143,00
Cafe creme	114.0368.466	143,00
Urban grey	114.0463.958	143,00
Carbon	114.0368.467	143,00

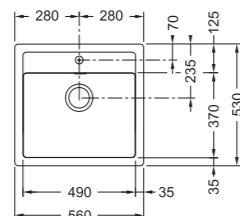

SIRIUS ja SINGLE Tectonite valamud



Mudel **SID 610-40**
Aluskapp 45 cm
Mõõdud 430 x 530 mm
Väljalõige 410 x 510 mm
Kausi mõõtmed 371 / 385 / 200 mm
Paigaldamine Süstistatav
Materjal Tectonite
Ventil Manuaalne 3 1/2" ventiil
Ventili juhtimine Käsitsi avamine / sulgemine
Ülevool Ümmargune ülevool
Segisti augud Segisti jaoks 35 mm auk

Värv	Artikkel	Hind €
Arktis weiss	114.0499.970	134,00
Cafe creme	114.0500.018	134,00
Urban grey	114.0500.012	134,00
Carbon	114.0500.019	134,00

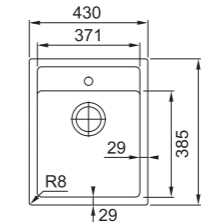

Mudel **SINGLE 1**
Aluskapp 45 cm
Mõõdud Ø 500 mm
Väljalõige Ø 480 mm
Kausi mõõtmed Ø 400 / 150 mm
Paigaldamine Süstistatav
Materjal Tectonite
Ventil Manuaalne 3 1/2" ventiil
Ventili juhtimine Käsitsi avamine / sulgemine
Ülevool Ümmargune ülevool
Segisti augud Segisti jaoks 35 mm auk

Värv	Artikkel	Hind €
Arktis weiss	114.0463.691	102,00
Cafe creme	114.0463.692	102,00
Urban grey	114.0463.698	102,00
Carbon	114.0463.694	102,00

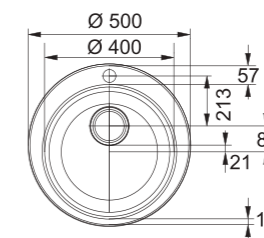

KERAAMILISED VALAMUD



- ① Mitmesugused lisatarvikud, näiteks rullmatt, võimaldavad valamu siledat pinda kasutada nõrutamiseks.



- ② Lõikelauda on kraanikausile lihtne paigutada ja samas kohas saab rohkem ära teha.



- ③ Roostevabast terasest nappu on lihtne kasutada, see on soliidne ja hõlpsasti puhastatav.



- ④ Kaetud ülevoolud ei häiri igapäevast tööd ja neid on lihtne hooldada.



- ⑤ Segisti stabiilne koht, võimaldades isegi väga suure segisti paigaldamist.





KÕRGVÄÄRTUSLIK JA PATENDEERITUD* SPETSIAALKERAAMIKA VASTAB TÄIUSLIKU KÖÖGI VAJADUSTELE.

Fraceram – kõva materjal

Franke keraamilised valamud on Fraceram materjalist valmistatud. See on eriti vastupidav spetsiaalne materjal, millele löiked ja löögid ei jäta mitte mingisuguseid jälgi.

Ajatu särav disain

Keraamika on peen materjal, mis suurepäraselt elukeskkonda sulandub – sobib nii puritaanse kaasaegse disainiga kui ka maamaja köögistiiliga. Tänu mitmekesisele värvivalikule on seda võimalik erinevat tooni tööpindade ja köögimööbli kombinatsioonidega.

Sile pind täiusliku puhtuse jaoks

Tänu glasuurile on Fracerami pind harukordselt sile ja seetõttu väga lihtsalt puhastatav. Seetõttu on Fraceram valamud ka suurepärase koht toitade ettevalmistamiseks.

Säravad hügieenilised omadused

Fraceram on ideaalne materjal valamud jaoks, millele püstitatakse kõrgendatud puhtuse nõuded. Fraceram valamud on koht, kus toiduaineid pestakse ja kus toimub toidu ettevalmistamine, kus toidunõusid, klaase ja potte pestakse. Fraceram on lõhna- ja maitseneutraalne materjal, mis looduslikest materjalidest kaasaegse tehnoloogiaga valmistatakse.

Püsivalt tugev, erakordselt vastupidav

Fraceram on löögikindel, kuuma- ja külmakindel, pleekimiskindel, samuti kraapimiskindel materjal. Erinevalt tavalisest keraamikast peab Fraceram valamud vastu ka metallist eseme poolt saadud tugevale löögile. Tänu nendele harukordsetele omadustele pakub Fraceram materjalist valamud rõõmu paljudeks aastateks.



* Kaitstud patendiga Nr. DE 101 45 537 B4

Keraamilised valamud aluskapi laiuse järgi

60 cm

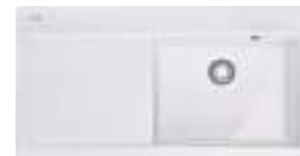

Mythos
MTK 611-100
1000 x 510 mm
86. lk.



Mythos
MTK 610-58
580 x 510 mm
87. lk.



Belfast
BAK 710
595 x 475 mm
89. lk.



SINGLE
SGK 610
600 x 500 mm
88. lk.

45 cm



Mythos
MTK 611-78
780 x 510 mm
87. lk.



SINGLE
SGK 611-86
860 x 435 mm
89. lk.

Värvid keraamiliste valamute jaoks



polaarvalge



magnolia



cashmere

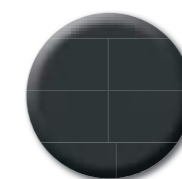

grafiit

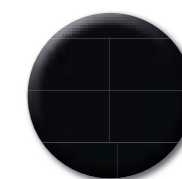

onyx



Pärlhall matt

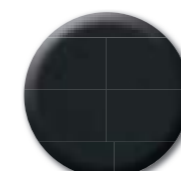

Antratsiit matt



MYTHOS keraamilised valamud

Lisad

1 112.0338.711
Lõikelaud- pähklipuu
300 x 400 mm
€ 59,40

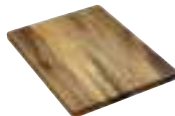

2 112.0030.882
Rullmatt painduv
468 x 420 mm
€ 69,00



Mudel **MTK 611-100**
Aluskapp 60 cm
Mõõdud 1000 x 510 mm
Väljalõige 980 x 490 mm (R=10 mm)
Kausi mõõtmed 492 / 372 / 190 mm
Paigaldamine Süvistatav
Materjal Fraceram
Ventil Komplektis 3½" ventiil
Ventili juhtimine Vajutusnupp ümmargune roostevaba teras
Ülevool Katteplaadiga ülevool
Segisti augud Segisti ja nupu jaoks 2x 35 mm auk

Värv	Artikkel	Hind €
Kauss paremal		
polaarvalge	124.0335.707	722,00
magnolia	124.0335.853	722,00
Onyx	124.0335.856	722,00

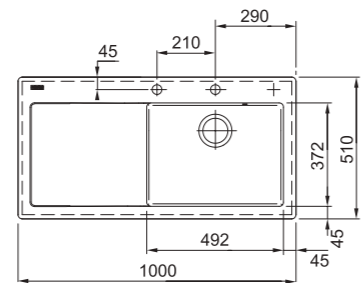
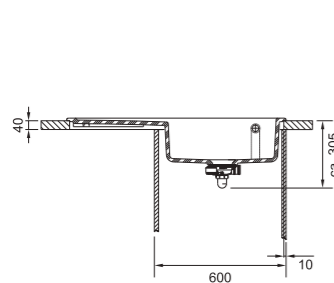
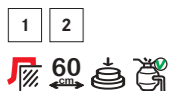

Värv	Artikkel	Hind €
Kauss vasakul		
polaarvalge	124.0335.708	722,00
magnolia	124.0335.859	722,00
Onyx	124.0335.863	722,00



Mudel **MTK 611-78**
Aluskapp 45 cm
Mõõdud 780 x 510 mm
Väljalõige 760 x 490 mm (R=10 mm)
Kausi mõõtmed 365 / 371 / 190 mm
Paigaldamine Süvistatav
Materjal Fraceram
Ventil Komplektis 3½" ventiil
Ventili juhtimine Vajutusnupp ümmargune roostevaba teras
Ülevool Katteplaadiga ülevool
Segisti augud Segisti ja nupu jaoks 2x 35 mm auk

Värv	Artikkel	Hind €
Kauss paremal		
polaarvalge	124.0433.384	694,00
magnolia	124.0433.385	694,00
Onyx	124.0433.433	694,00
Antratsiit matt	124.0433.440	694,00

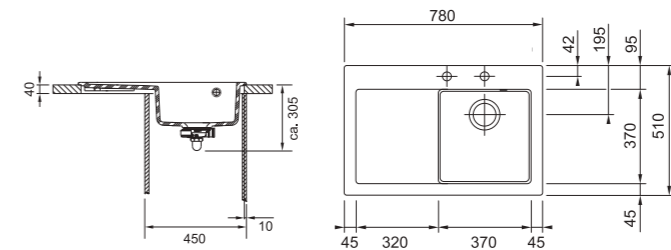
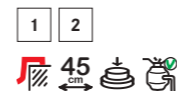

Värv	Artikkel	Hind €
Kauss vasakul		
polaarvalge	124.0433.442	694,00
magnolia	124.0433.443	694,00
Onyx	124.0433.445	694,00
Antratsiit matt	124.0433.447	694,00



Mudel **MTK 610-58**
Aluskapp 60 cm
Mõõdud 580 x 510 mm
Väljalõige 560 x 490 mm (R=10 mm)
Kausi mõõtmed 490 / 377 / 190 mm
Paigaldamine Süvistatav
Materjal Fraceram
Ventil Komplektis 3½" ventiil
Ventili juhtimine Vajutusnupp ümmargune roostevaba teras
Ülevool Katteplaadiga ülevool
Segisti augud Segisti ja nupu jaoks 2x 35 mm auk

Värv	Artikkel	Hind €
polaarvalge	124.0335.706	515,00
magnolia	124.0335.844	515,00
cashmere	124.0335.845	515,00
grafiit	124.0335.850	515,00
Onyx	124.0335.851	515,00

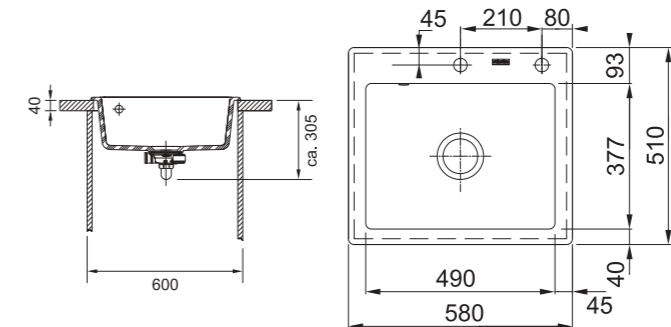
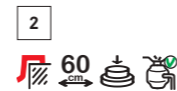

Pärlihall matt	124.0380.249	515,00
Antratsiit matt	124.0380.250	515,00



SINGLE keraamilised valamud



Mudel **SGK 610**
 Aluskapp 60 cm
 Mõõdud 600 x 500 mm
 Väljalõige 570 x 470 mm (R=10 mm)
 Kausi mõõtmed 520 / 420 / 200 mm
 Paigaldamine Suvistatav
 Materjal Franke keraamika
 Ventiiil 3½" nupuga
 Ventiiili juhtimine Keerata nupp
 Ülevool Katteplaadiga ülevool
 Segisti augud Segisti ja nupu jaoks 2x 35 mm auk

Värv	Artikkel	Hind €
Valge läikiv	124.0586.209	304,00
Must matt	124.0586.221	304,00

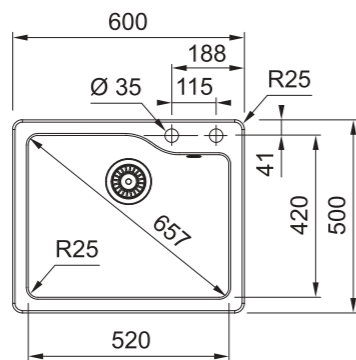

SINGLE keraamilised valamud



Mudel **SGK 611-86**
 Aluskapp 45 cm
 Mõõdud 860 x 435 mm
 Väljalõige 830 x 405 mm (R=18 mm)
 Kausi mõõtmed 353 / 350 / 180 mm
 Kausi asukoht Pööratav
 Paigaldamine Suvistatav
 Materjal Franke keraamika
 Ventiiil 3½" nupuga
 Ventiiili juhtimine Keerata nupp
 Ülevool Katteplaadiga ülevool
 Segisti augud Segisti ja nupu jaoks 2x 35 mm auk

Värv	Artikkel	Hind €
Valge läikiv	124.0586.210	409,00
Must matt	124.0586.222	409,00

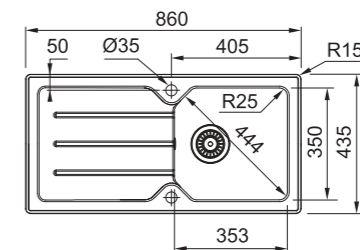

BELFAST keraamilised valamud



Mudel **BAK 710**
 Aluskapp 60 cm
 Mõõdud 595 x 475 mm
 Kausi mõõtmed 545 / 410 / 200 mm
 Paigaldamine Kapile paigaldatav valamu
 Materjal Franke keraamika
 Ventiiil Komplektis 3½" ventiiil
 Ventiiili juhtimine Käsitsi avamine / sulgemine
 Segisti augud ilma segisti aukudeta

Värv	Artikkel	Hind €
Valge läikiv	130.0085.739	420,00

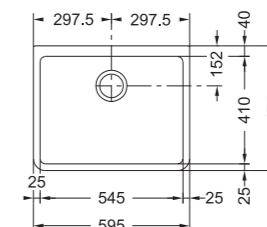

ALTPOOLT MONTEERITAVAD VALAMUD



① Kahetasandiline kauss lisab valamud igapäevasel kasutamisel uue mõõtme ja kasutamine muutus mitmekülgsemaks.



② Katteplaadiga kaetud äravool võimaldab hoida püsivat puhas ilmet isegi üldpuhastuse vaheaegade ajal.



③ Vajutusnappu on lihtne vajutada isegi küünarnukiga ja see näeb tööpinnal täiuslik välja.



④ Kattega ülevoolu on lihtne puhastada ja sellel on diskreetne väljanägemine.



⑤ Erinevad lisaseadmed, näiteks lõikelaud ja rullmatt, võimaldavad teil samas kausis rohkem teha.



Altpoolt monteeritavad roostevabast terasest valamud vastavalt aluskapi laiusele.

60 cm



Mythos
MYX 110-50
540 x 440 mm
94. lk.



Maris
MRX 160-34-19
591 x 436 mm
98. lk.



Franke Box
BXX 210/110-50
540 x 450 mm
97. lk.



Maris
MRX 110-50
540 x 440 mm
99. lk.



Franke Box
BXX 210/110-45
490 x 450 mm
97. lk.



Aton
ANX 110-48
510 x 430 mm
101. lk.

50 cm



Mythos
MYX 110-45
490 x 440 mm
95. lk.

UUDIS



Franke Box
BXX 210/110-40
440 x 450 mm
97. lk.



Maris
MRX 110-45
490 x 440 mm
99. lk.



Maris
MRX 110-40
440 x 440 mm
100. lk.

45 cm



Franke Box
BXX 210/110-34
380 x 450 mm
97. lk.



Maris
MRX 110-34
380 x 440 mm
100. lk.



Aton
ANX 110-34
370 x 430 mm
101. lk.

40 cm



Franke Box
BXX 210/110-68
725 x 450 mm
96. lk.



Franke Box
BXX 210/110-54
580 x 450 mm
96. lk.



Maris
MRX 110-70
740 x 440 mm
99. lk.



Maris
MRX 110-55
590 x 440 mm
99. lk.

80 cm

Altpoolt monteeritavad Fraganit valamud vastavalt aluskapi laiusele.

60 cm



Kubus 2
KNG 110-52
560 x 460 mm
103. lk.



Kubus
KBG 160
558 x 460 mm
104. lk.



Kubus
KBG 110-50
540 x 440 mm
105. lk.

50 cm

45 cm



Kubus 2
KNG 110-37
410 x 460 mm
103. lk.

40 cm



Kubus
KBG 110-34
380 x 440 mm
105. lk.

80 cm



Kubus 2
KNG 110-62
760 x 460 mm
102. lk.

Altpoolt monteeritavad keraamilised valamud vastavalt aluskapi laiusele.



Kubus
KBK 160
545 x 445 mm
106. lk.



Kubus
KBK 110-50
545 x 445 mm
107. lk.



Kubus
KBK 110-40
445 x 445 mm
107. lk.



Kubus
KBK 110-70
745 x 445 mm
107. lk.



MYTHOS roostevabast terasest altpoolt monteeritavad valamud

Lisad

- | | | | |
|---|---|---|---|
| <p>1 112.0599.107</p> <p>Nõrutuskauss, rv teras plastik raam
180 x 412 x 60 mm
€ 98,40</p>  | <p>2 112.0591.082</p> <p>Lõikelaud Stonepaper Slate
180 x 412 mm
€ 94,60</p>  | <p>3 112.0591.081</p> <p>Rullmatt painduv
252 x 424 mm
€ 54,00</p>  | <p>4 112.0602.288</p> <p>Rv Mobiilne nõruti plastik raamis
298 x 412 mm
€ 84,90</p>  |
|---|---|---|---|



Mudel **MYX 110-50**
 Aluskapp 60 cm
 Mõõdud 540 x 440 mm (R = 10 mm)
 Väljalõige 500 x 400 mm (R = 25mm)
 Kausi mõõtmed 500 / 400 / 200 mm (R = 25 mm)
 Paigaldamine Altpoolt monteeritav
 Materjal Roostevaba teras poleeritud
 Ventiiil Integreeritud ventiiil
 Ventiiili juhtimine Vajutusnupp ümmargune roostevaba teras (tööpinnale on vajalik auk 35mm)
 Ülevool Katteplaadiga ülevool

Komplekt	Artikkel	Hind €
Valamu ventiiiliga	122.0601.316	500,00

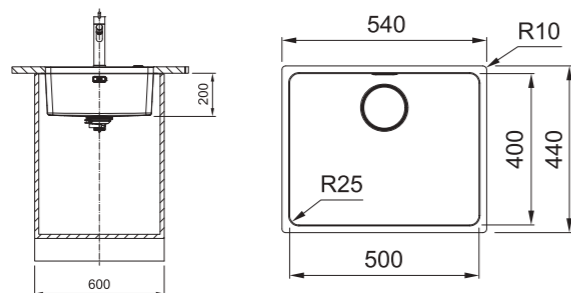

Mudel **MYX 110-45**
 Aluskapp 50 cm
 Mõõdud 490 x 440 mm (R = 10 mm)
 Väljalõige 450 x 400 mm (R = 25mm)
 Kausi mõõtmed 450 / 400 / 200 mm (R = 25 mm)
 Paigaldamine Altpoolt monteeritav
 Materjal Roostevaba teras poleeritud
 Ventiiil Integreeritud ventiiil
 Ventiiili juhtimine Vajutusnupp ümmargune roostevaba teras (tööpinnale on vajalik auk 35mm)
 Ülevool Katteplaadiga ülevool

Komplekt	Artikkel	Hind €
Valamu ventiiiliga	122.0601.315	483,00

UUDIS

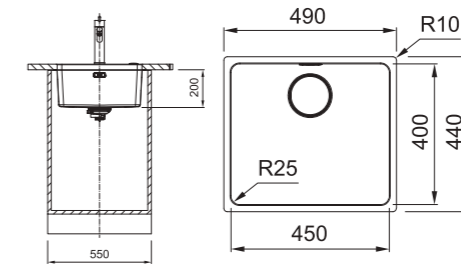



BOX roostevabast terasest altpoolt monteeritavad valamud

Lisad

1	112.0394.981	Roostevabast terasest nõrutuskauss plastkäepidemetega 429 x 156 mm € 91,50	2	112.0539.120	Lõikelaud-plastik 429 x 180 mm € 47,80	3	112.0080.355	Rullmatt painduv 468 x 440 mm € 72,10	4	112.0204.360	Rv Mobiilne nõruti plastik raamis 326 x 440 x 23 mm € 101,90
---	--------------	--	---	--------------	--	---	--------------	---	---	--------------	--

	Mudel BXX 210/110-68 Aluskapp 80 cm Mõõdud 725 x 450 mm Väljalõige altpoolt monteerimiseks 685 x 410 mm (R = 12 mm) Kausi mõõtmed 685 / 410 / 200 mm Paigaldamine SlimTop, tasapinnaline või altpoolt Materjal Roostevaba teras Ventii Integreeritud või 3½" ventiiil Ventiiil juhtimine Vajutusnupp ümmargune roostevaba teras või käsitsi Vajutusnupu auk 35mm Ülevool Katteplaadiga ülevool Töötasapinna paksus min 20 mm	Komplekt	Artikkel	Hind €
		Valamu ventiiliga	127.0539.907	434,00
		Valamu ventiiliga	127.0539.906	393,00

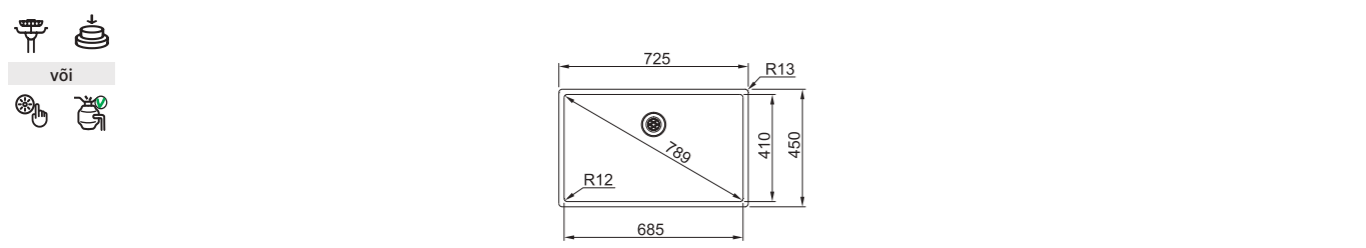

	Mudel BXX 210/110-54 Aluskapp 60 cm Altpoolt monteeritavm skapim 80 cm Mõõdud 580 x 450 mm Väljalõige altpoolt monteerimiseks 540 x 410 mm (R = 12 mm) Kausi mõõtmed 540 / 410 / 200 mm Paigaldamine SlimTop, tasapinnaline või altpoolt Materjal Roostevaba teras Ventii Integreeritud või 3½" ventiiil Ventiiil juhtimine Vajutusnupp ümmargune roostevaba teras või käsitsi Vajutusnupu auk 35mm Ülevool Katteplaadiga ülevool Töötasapinna paksus min 20 mm	Komplekt	Artikkel	Hind €
		Valamu ventiiliga	127.0375.278	383,00
		Valamu ventiiliga	127.0372.488	338,00

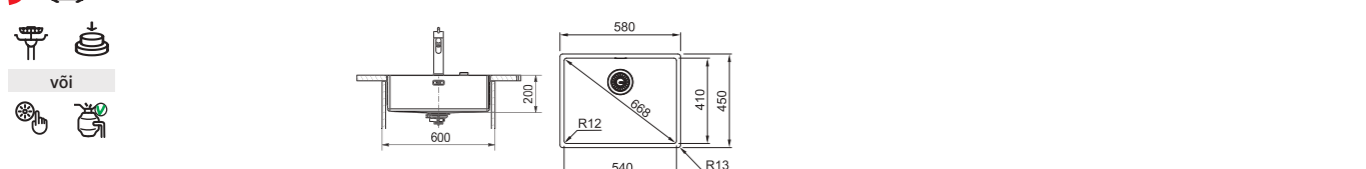

	Mudel BXX 210/110-50 Aluskapp 60 cm Mõõdud 540 x 450 mm Väljalõige altpoolt monteerimiseks 500 x 410 mm (R = 12 mm) Kausi mõõtmed 500 / 410 / 200 mm Paigaldamine SlimTop, tasapinnaline või altpoolt Materjal Roostevaba teras Ventii Integreeritud või 3½" ventiiil Ventiiil juhtimine Vajutusnupp ümmargune roostevaba teras või käsitsi Vajutusnupu auk 35mm Ülevool Katteplaadiga ülevool Töötasapinna paksus min 20 mm	Komplekt	Artikkel	Hind €
		Valamu ventiiliga	127.0375.273	374,00
		Valamu ventiiliga	127.0374.206	329,00

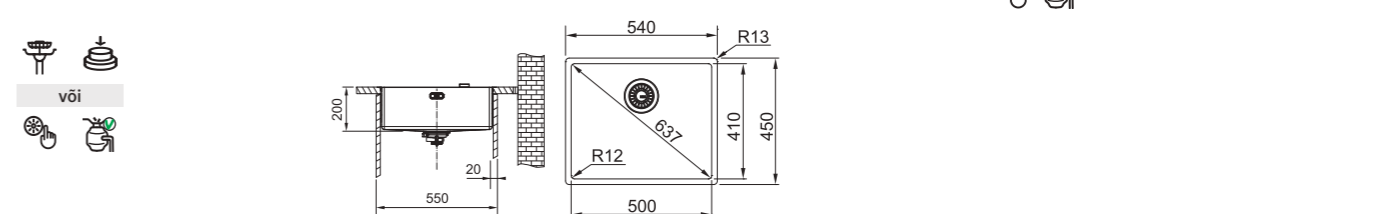

	Mudel BXX 210/110-45 Aluskapp 50 cm Altpoolt monteeritavm skapim 60 cm Mõõdud 490 x 450 mm Väljalõige altpoolt monteerimiseks 450 x 410 mm (R = 12 mm) Kausi mõõtmed 450 / 410 / 200 mm Paigaldamine SlimTop, tasapinnaline või altpoolt Materjal Roostevaba teras Ventii Integreeritud või 3½" ventiiil Ventiiil juhtimine Vajutusnupp ümmargune roostevaba teras või käsitsi Vajutusnupu auk 35mm Ülevool Katteplaadiga ülevool Töötasapinna paksus min 20 mm	Komplekt	Artikkel	Hind €
		Valamu ventiiliga	127.0375.257	360,00
		Valamu ventiiliga	127.0372.489	315,00

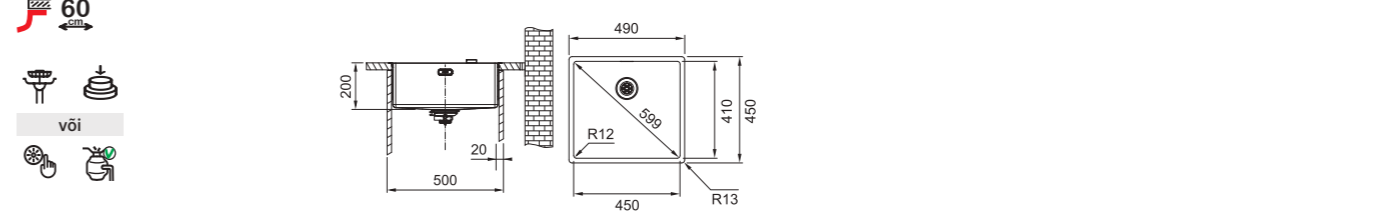

	Mudel BXX 210/110-40 Aluskapp 45 cm Altpoolt monteeritavm skapim 50 cm Mõõdud 440 x 450 mm Väljalõige altpoolt monteerimiseks 400 x 410 mm (R = 12 mm) Kausi mõõtmed 400 / 410 / 200 mm Paigaldamine SlimTop, tasapinnaline või altpoolt Materjal Roostevaba teras Ventii Integreeritud või 3½" ventiiil Ventiiil juhtimine Vajutusnupp ümmargune roostevaba teras või käsitsi Vajutusnupu auk 35mm Ülevool Katteplaadiga ülevool Töötasapinna paksus min 20 mm	Komplekt	Artikkel	Hind €
		Valamu ventiiliga	127.0375.252	351,00
		Valamu ventiiliga	127.0375.284	306,00

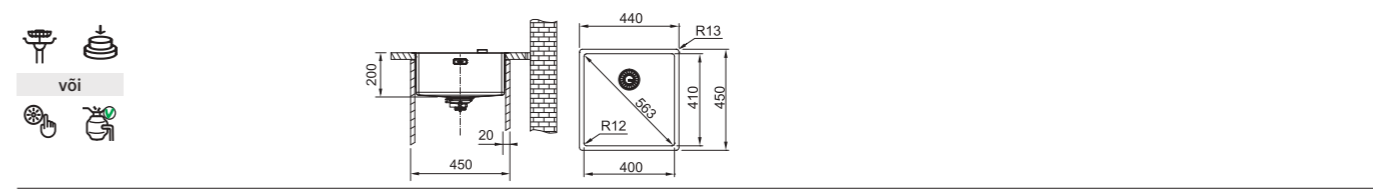

	Mudel BXX 210/110-34 Aluskapp 40 cm Altpoolt monteeritavm skapim 45 cm Mõõdud 380 x 450 mm Väljalõige altpoolt monteerimiseks 340 x 410 mm (R = 12 mm) Kausi mõõtmed 340 / 410 / 200 mm Paigaldamine SlimTop, tasapinnaline või altpoolt Materjal Roostevaba teras Ventii Integreeritud või 3½" ventiiil Ventiiil juhtimine Vajutusnupp ümmargune roostevaba teras või käsitsi Vajutusnupu auk 35mm Ülevool Katteplaadiga ülevool Töötasapinna paksus min 20 mm	Komplekt	Artikkel	Hind €
		Valamu ventiiliga	127.0374.687	333,00
		Valamu ventiiliga	127.0372.501	292,00

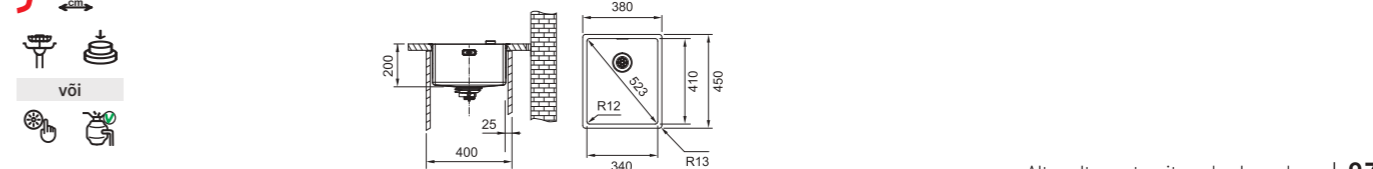



MARIS roostevabast terasest altpoolt monteeritavad valamud

Lisad

1	112.0057.850	2	112.0530.071	3	112.0030.882	4	112.0188.651
Nõrutuskauss- roostevaba teras 412 x 172 mm € 38,60		Lõikelaud-plastik 200 x 440 x 16 mm € 38,60		Rullmatt painduv 468 x 420 mm € 69,00		Rv Mobiilne nõruti plastik raamis 342 x 430 x 22 mm € 93,70	



Mudel **MRX 160-34-19**
 Aluskapp 60 cm
 Mõõdud 595 x 440 mm
 Väljalõige 555 x 400 mm (R = 16 mm)
 Kausi mõõtmed 340 / 400 / 180 + 190 / 400 / 130 mm
 Paigaldamine Altpoolt monteeritav
 Materjal Roostevabast teras harjatud
 Ventiiil Manuaalne 3½" ventiil
 Ventiiili juhtimine Käsitsi avamine / sulgemine
 Ülevool Katteplaadiga ülevool
 Jäätmeपुरustaja Ühilduv
 Tööpind min 20 mm

Komplekt	Artikkel	Hind €
Valamu ventiiliga	122.0594.258	475,00

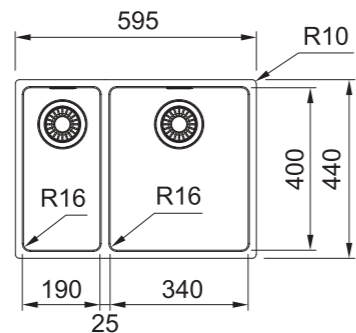
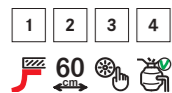

Mudel **MRX 110-70**
 Aluskapp 80 cm
 Mõõdud 740 x 440 mm
 Väljalõige 700 x 400 mm (R = 16 mm)
 Kausi mõõtmed 700 / 400 / 180 mm
 Paigaldamine Altpoolt monteeritav
 Materjal Roostevabast teras harjatud
 Ventiiil Manuaalne 3½" ventiil
 Ventiiili juhtimine Käsitsi avamine / sulgemine
 Ülevool Katteplaadiga ülevool
 Jäätmeपुरustaja Ühilduv
 Tööpind min 20 mm

Komplekt	Artikkel	Hind €
Valamu ventiiliga	122.0531.911	341,00

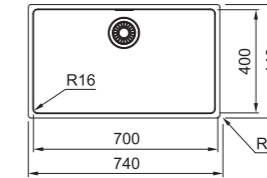
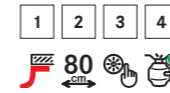

Mudel **MRX 110-55**
 Aluskapp 80 cm
 Mõõdud 590 x 440 mm
 Väljalõige 550 x 400 mm (R = 16 mm)
 Kausi mõõtmed 550 / 400 / 180 mm
 Paigaldamine Altpoolt monteeritav
 Materjal Roostevabast teras harjatud
 Ventiiil Manuaalne 3½" ventiil
 Ventiiili juhtimine Käsitsi avamine / sulgemine
 Ülevool Katteplaadiga ülevool
 Jäätmeपुरustaja Ühilduv
 Tööpind min 20 mm

Komplekt	Artikkel	Hind €
Valamu ventiiliga	122.0553.947	262,00

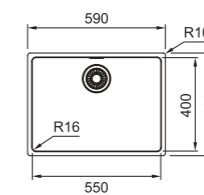
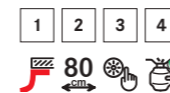

Mudel **MRX 110-50**
 Aluskapp 60 cm
 Mõõdud 540 x 440 mm
 Väljalõige 500 x 400 mm (R = 16 mm)
 Kausi mõõtmed 500 / 400 / 180 mm
 Paigaldamine Altpoolt monteeritav
 Materjal Roostevabast teras harjatud
 Ventiiil Manuaalne 3½" ventiil
 Ventiiili juhtimine Käsitsi avamine / sulgemine
 Ülevool Katteplaadiga ülevool
 Jäätmeपुरustaja Ühilduv
 Tööpind min 20 mm

Komplekt	Artikkel	Hind €
Valamu ventiiliga	122.0531.808	251,00

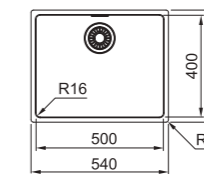
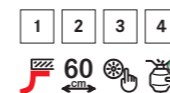

Mudel **MRX 110-45**
 Aluskapp 50 cm
 Mõõdud 490 x 440 mm
 Väljalõige 450 x 400 mm (R = 16 mm)
 Kausi mõõtmed 450 / 400 / 180 mm
 Paigaldamine Altpoolt monteeritav
 Materjal Roostevabast teras harjatud
 Ventiiil Manuaalne 3½" ventiil
 Ventiiili juhtimine Käsitsi avamine / sulgemine
 Ülevool Katteplaadiga ülevool
 Jäätmeपुरustaja Ühilduv
 Tööpind min 20 mm

Komplekt	Artikkel	Hind €
Valamu ventiiliga	122.0553.943	240,00

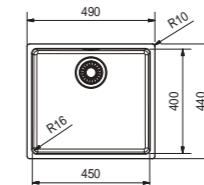



MARIS roostevabast terasest altpoolt monteeritavad valamud

Lisad

1 112.0057.850 Nõrutuskauss- roostevaba teras 412 x 172 mm € 38,60	2 112.0530.071 Lõikelaud-plastik 200 x 440 x 16 mm € 38,60	3 112.0030.882 Rollmatt paindub 468 x 420 mm € 69,00	4 112.0188.651 Rv Mobiilne nõruti plastik raamis 342 x 430 x 22 mm € 93,70
--	--	--	--



Mudel **MRX 110-40**
Aluskapp 50 cm
Möödud 440 x 440 mm
Väljalõige 400 x 400 mm (R = 16 mm)
Kausi mõõtmed 400 / 400 / 180 mm
Paigaldamine Altpoolt monteeritav
Materjal Roostevabast teras harjatud
Ventil Manuaalne 3 1/2" ventiil
Ventili juhtimine Käsitsi avamine / sulgemine
Ülevool Katteplaadiga ülevool
Jäätmeपुरustaja Ühilduv
Tööpind min 20 mm

Komplekt	Artikkel	Hind €
Valamu ventiiliga	122.0531.643	230,00

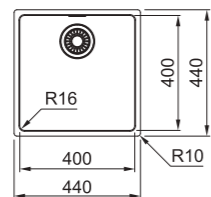

Mudel **MRX 110-34**
Aluskapp 45 cm
Möödud 380 x 440 mm
Väljalõige 340 x 400 mm (R = 16 mm)
Kausi mõõtmed 340 / 400 / 180 mm
Paigaldamine Altpoolt monteeritav
Materjal Roostevabast teras harjatud
Ventil Manuaalne 3 1/2" ventiil
Ventili juhtimine Käsitsi avamine / sulgemine
Ülevool Katteplaadiga ülevool
Jäätmeपुरustaja Ühilduv
Tööpind min 20 mm

Komplekt	Artikkel	Hind €
Valamu ventiiliga	122.0531.850	224,00

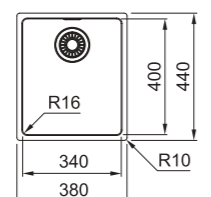

ATON roostevabast terasest altpoolt monteeritavad valamud



Mudel **ANX 110-48**
Aluskapp 60 cm
Möödud 510 x 430 mm
Väljalõige Šablooni järgi
Kausi mõõtmed 480 / 400 / 190 mm
Paigaldamine Altpoolt monteeritav
Materjal Roostevaba teras poleeritud
Ventil Nupuga avatav 3 1/2" ventiil
Ventili juhtimine Ventili juhtimine Tõstenupp (auk 18mm)
Ülevool Katteplaadiga ülevool
Jäätmeपुरustaja Ühilduv

Komplekt	Artikkel	Hind €
Valamu ventiiliga	122.0336.883	169,00

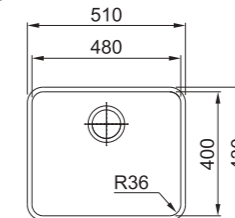
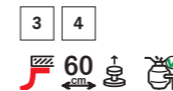

Mudel **ANX 110-34**
Aluskapp 45 cm
Möödud 370 x 430 mm
Väljalõige Šablooni järgi
Kausi mõõtmed 340 / 400 / 190 mm
Paigaldamine Altpoolt monteeritav
Materjal Roostevaba teras poleeritud
Ventil Nupuga avatav 3 1/2" ventiil
Ventili juhtimine Ventili juhtimine Tõstenupp (auk 18mm)
Ülevool Katteplaadiga ülevool
Jäätmeपुरustaja Ühilduv

Komplekt	Artikkel	Hind €
Valamu ventiiliga	122.0336.885	157,00

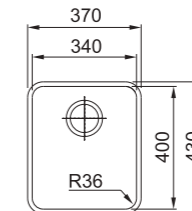
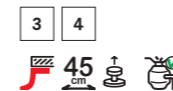



KUBUS 2 Fragranit altpoolt monteeritavad valamud

Lisad

1	112.0066.060	Roostevabast terasest nõrutus-kauss plastkäepidemetega 156 x 417 x 54 mm € 91,50
2	112.0256.867	Rullmatt painduv 298 x 410 mm € 36,70
3	112.0204.360	Rv Mobiilne nõruti plastik raamis 326 x 440 x 23 mm € 101,90



Mudel **KNG 110-62**
 Aluskapp 80 cm
 Mõõdud 760 x 460 mm
 Väljalõige 720 x 420 mm (R=10 mm)
 Kausi mõõtmed 620 / 420 / 200 mm
 Paigaldamine Altpoolt monteeritav
 Kausi asukoht Pööratav
 Materjal Fragranit+ / antibakteriaalne
 Ventiiil Sealhulgas ventiiil 3½" vajutusnupuga
 Ventiiili juhtimine Vajutusnupp ümmargune roostevaba teras (tööpinnale on vajalik auk 35mm)
 Ventiiili kate Nelinurkne roostevabast terasest kate
 Ülevool Katteplaadiga ülevool
 Segisti augud ilma segisti aukudeta (2 x 35 mm altpoolt puuritud augud)
 Erimärkused Kausi teine tasand on vajalik lisade jaoks

Värv	Artikkel	Hind €
polaarvalge	125.0512.517	453,00
cashmere	125.0512.516	453,00
kivihall	125.0512.518	453,00
grafiit	125.0512.512	453,00
onyx	125.0512.515	453,00
must matt	125.0627.321	453,00

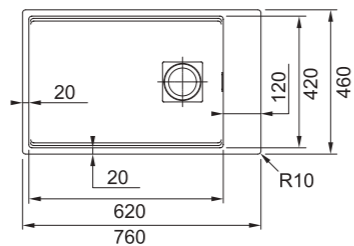
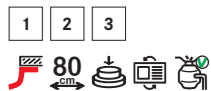

Augufrees 35mm Fragranit ja Tectonite valamutele
 Art.Nr 112.0473.656 € 3,90



Mudel **KNG 110-52**
 Aluskapp 60 cm
 Mõõdud 560 x 460 mm
 Väljalõige 520 x 420 mm (R=10 mm)
 Kausi mõõtmed 520 / 420 / 200 mm
 Paigaldamine Altpoolt monteeritav
 Materjal Fragranit+ / antibakteriaalne
 Ventiiil Sealhulgas ventiiil 3½" vajutusnupuga
 Ventiiili juhtimine Vajutusnupp ümmargune roostevaba teras (tööpinnale on vajalik auk 35mm)
 Ventiiili kate Nelinurkne roostevabast terasest kate
 Ülevool Katteplaadiga ülevool
 Segisti augud ilma segisti aukudeta
 Erimärkused Kausi teine tasand on vajalik lisade jaoks

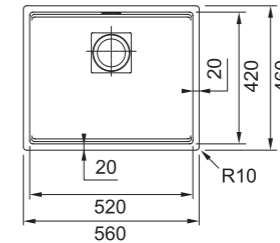

Värv	Artikkel	Hind €
polaarvalge	125.0512.506	377,00
cashmere	125.0512.505	377,00
kivihall	125.0512.507	377,00
grafiit	125.0512.502	377,00
onyx	125.0512.504	377,00
must matt	125.0627.319	377,00

UUDIS



Mudel **KNG 110-37**
 Aluskapp 45 cm
 Mõõdud 410 x 460 mm
 Väljalõige 370 x 420 mm (R=10 mm)
 Kausi mõõtmed 370 / 420 / 200 mm
 Paigaldamine Altpoolt monteeritav
 Materjal Fragranit+ / antibakteriaalne
 Ventiiil Sealhulgas ventiiil 3½" vajutusnupuga
 Ventiiili juhtimine Vajutusnupp ümmargune roostevaba teras (tööpinnale on vajalik auk 35mm)
 Ventiiili kate Nelinurkne roostevabast terasest kate
 Ülevool Katteplaadiga ülevool
 Segisti augud ilma segisti aukudeta
 Erimärkused Kausi teine tasand on vajalik lisade jaoks

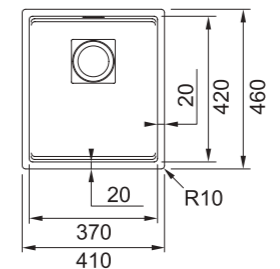

Värv	Artikkel	Hind €
polaarvalge	125.0512.451	348,00
cashmere	125.0512.450	348,00
kivihall	125.0512.452	348,00
grafiit	125.0512.447	348,00
onyx	125.0512.449	348,00
must matt	125.0627.320	348,00

UUDIS





KUBUS Fragranit altpoolt monteeritavad valamud

Lisad

1 112.0017.788
Nõrutuskauss- roostevaba teras
412 x 172 x 55 mm
€ 53,80



2 112.0030.882
Rullmatt painduv
468 x 420 mm
€ 69,00



3 112.0188.651
Rv Mobiilne nõruti plastik raamis
342 x 430 x 22 mm
€ 93,70



Mudel **KBG 160**
Aluskapp **60 cm**
Mõõdud **558 x 460 mm**
Väljalõige Šablooni järgi
Kausi mõõtmed **340 / 400 / 200 + 160 / 400 / 130 mm**
Paigaldamine Altpoolt monteeritav
Materjal **Fragranit+ / antibakteriaalne**
Ventil Sealhulgas ventiil 3½" vajutusnupuga
Ventili juhtimine Vajutusnupp ümmargune roostevaba teras või käsitsi (tööpinnale on vajalik auk 35mm)
Ventili väikese kausi jaoks Manuaalne 3½" ventiil
Ülevool Katteplaadiga ülevool
Segisti augud ilma segisti aukudeta

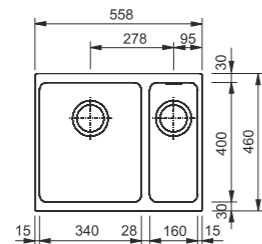

Värv	Artikkel	Hind €
	Vajutusnupp ümmargune roostevaba teras	
	125.0477.757	381,00
	125.0477.761	381,00
	125.0477.756	381,00
	125.0477.755	381,00
	125.0477.754	381,00
	125.0478.124	296,00
	125.0478.128	296,00
	125.0478.123	296,00
	125.0478.122	296,00
	125.0478.121	296,00



Mudel **KBG 110-50**
Aluskapp **60 cm**
Mõõdud **540 x 440 mm**
Väljalõige Šablooni järgi
Kausi mõõtmed **500 / 400 / 200 mm**
Paigaldamine Altpoolt monteeritav
Materjal **Fragranit+ / antibakteriaalne**
Ventil Sealhulgas ventiil 3½" vajutusnupuga
Ventili juhtimine Vajutusnupp ümmargune roostevaba teras või käsitsi (tööpinnale on vajalik auk 35mm)
Ülevool Katteplaadiga ülevool
Segisti augud ilma segisti aukudeta

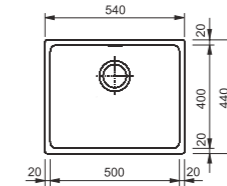

Värv	Artikkel	Hind €
	Vajutusnupp ümmargune roostevaba teras	
	125.0477.597	351,00
	125.0477.676	351,00
	125.0477.596	351,00
	125.0477.595	351,00
	125.0477.594	351,00
	125.0478.083	266,00
	125.0478.087	266,00
	125.0478.081	266,00
	125.0477.950	266,00
	125.0477.949	266,00



Mudel **KBG 110-34**
Aluskapp **40 cm**
Mõõdud **380 x 440 mm**
Väljalõige Šablooni järgi
Kausi mõõtmed **340 / 400 / 200 mm**
Paigaldamine Altpoolt monteeritav
Materjal **Fragranit+ / antibakteriaalne**
Ventil Sealhulgas ventiil 3½" vajutusnupuga
Ventili juhtimine Vajutusnupp ümmargune roostevaba teras või käsitsi (tööpinnale on vajalik auk 35mm)
Ülevool Katteplaadiga ülevool
Segisti augud ilma segisti aukudeta

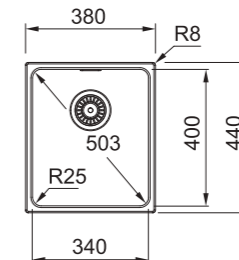

Värv	Artikkel	Hind €
	Vajutusnupp ümmargune roostevaba teras	
	125.0477.706	317,00
	125.0477.710	317,00
	125.0477.702	317,00
	125.0477.701	317,00
	125.0477.680	317,00
	125.0478.104	232,00
	125.0478.108	232,00
	125.0478.103	232,00
	125.0478.102	232,00
	125.0478.090	232,00



KUBUS Fraceram altpoolt monteeritavad valamud

Lisad

- | | |
|---|---|
| <p>1 112.0030.882</p> <p>Rullmatt painduv
468 x 420 mm
€ 69,00</p> | <p>2 112.0188.651</p> <p>Rv Mobiilne nõruti plastik raamis
342 x 430 x 22 mm
€ 93,70</p> |
|---|---|



Mudel **KBK 160**
 Aluskapp 60 cm
 Mõõdud 545 x 445 mm
 Väljalõige 495 x 375 mm (R = 15 mm)
 Kausi mõõtmed 375 / 385 / 185 + 115 / 385 / 115 mm
 Paigaldamine Altpoolt monteeritav
 Materjal Fraceram
 Ventiiil Sealhulgas ventiil 3½" vajutusnupuga
 Ventiiili juhtimine Vajutusnupp ümmargune roostevaba teras
 (tööpinnale on vajalik auk 35mm)
 Ventiiil väikese kausi jaoks
 Segisti augud ilma segisti aukudeta

Värv	Artikkel	Hind €
	126.0335.714	546,00
	126.0335.884	546,00
	126.0335.887	546,00
	126.0380.348	546,00

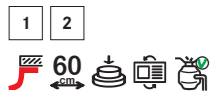

Tähelepanu mõõdud!
 Keraamilise valamü mõõdud võivad tehnoloogias tulenevalt erineda joonistel toodud mõõtudest. Seepärast soovime väljalõige tööpinna teha konkreetse valamü mõõtude järgi. Samuti on keraamilisel valamul lubatud minimaalne kõverus.

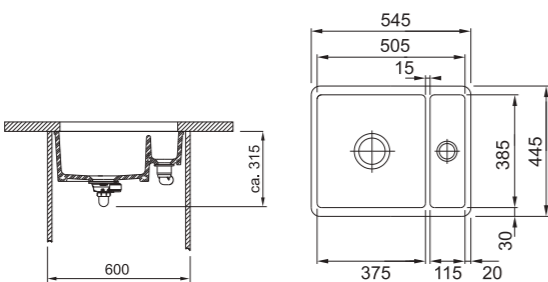

Mudel **KBK 110-50**
 Aluskapp 60 cm
 Mõõdud 545 x 445 mm
 Väljalõige 495 x 375 mm (R = 15 mm)
 Kausi mõõtmed 505 / 385 / 185 mm
 Paigaldamine Altpoolt monteeritav
 Materjal Fraceram
 Ventiiil Sealhulgas ventiil 3½" vajutusnupuga
 Ventiiili juhtimine Vajutusnupp ümmargune roostevaba teras
 (tööpinnale on vajalik auk 35mm)
 Ülevool Katteplaadiga ülevool
 Segisti augud ilma segisti aukudeta

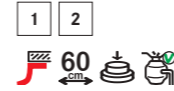

Tähelepanu mõõdud!
 Keraamilise valamü mõõdud võivad tehnoloogias tulenevalt erineda joonistel toodud mõõtudest. Seepärast soovime väljalõige tööpinna teha konkreetse valamü mõõtude järgi. Samuti on keraamilisel valamul lubatud minimaalne kõverus.

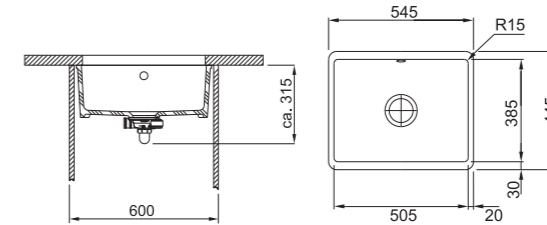

Värv	Artikkel	Hind €
	126.0335.712	494,00
	126.0335.880	494,00
	126.0335.881	494,00
	126.0335.882	494,00
	126.0335.883	494,00
	126.0380.349	494,00
	126.0380.350	494,00



Mudel **KBK 110-40**
 Aluskapp 50 cm
 Mõõdud 445 x 445 mm
 Väljalõige 395 x 375 mm (R = 15 mm)
 Kausi mõõtmed 405 / 385 / 175 mm
 Paigaldamine Altpoolt monteeritav
 Materjal Fraceram
 Ventiiil Sealhulgas ventiil 3½" vajutusnupuga
 Ventiiili juhtimine Vajutusnupp ümmargune roostevaba teras
 (tööpinnale on vajalik auk 35mm)
 Ülevool Katteplaadiga ülevool
 Segisti augud ilma segisti aukudeta



Tähelepanu mõõdud!
 Keraamilise valamü mõõdud võivad tehnoloogias tulenevalt erineda joonistel toodud mõõtudest. Seepärast soovime väljalõige tööpinna teha konkreetse valamü mõõtude järgi. Samuti on keraamilisel valamul lubatud minimaalne kõverus.

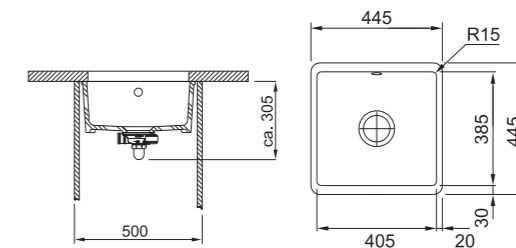

Värv	Artikkel	Hind €
	126.0335.711	437,00
	126.0335.875	437,00
	126.0335.878	437,00
	126.0380.352	437,00



Mudel **KBK 110-70**
 Aluskapp 80 cm
 Mõõdud 745 x 445 mm
 Väljalõige 695 x 375 mm (R = 15 mm)
 Kausi mõõtmed 705 / 385 / 175 mm
 Paigaldamine Altpoolt monteeritav
 Materjal Fraceram
 Ventiiil Sealhulgas ventiil 3½" vajutusnupuga
 Ventiiili juhtimine Vajutusnupp ümmargune roostevaba teras
 (tööpinnale on vajalik auk 35mm)
 Ülevool Katteplaadiga ülevool
 Segisti augud ilma segisti aukudeta



Tähelepanu mõõdud!
 Keraamilise valamü mõõdud võivad tehnoloogias tulenevalt erineda joonistel toodud mõõtudest. Seepärast soovime väljalõige tööpinna teha konkreetse valamü mõõtude järgi. Samuti on keraamilisel valamul lubatud minimaalne kõverus.

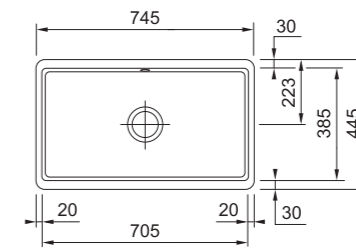

Värv	Artikkel	Hind €
	126.0381.439	744,00
	126.0381.440	744,00
	126.0381.512	744,00
	126.0381.518	744,00

SEGISTID



① Sensorüliti võimaldab segistit juhtida puudutuse kaudu



② Laminaarvool vähendab oluliselt pritsimist, sest juga on ühtlane.



③ Suurem paindlikkus ja funktsionaalsus ühe mudeli erinevate võimaluste kaudu

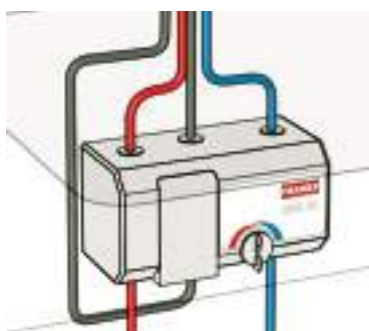

④ Sensoriga segisti juhtpaneel asub tööpinna all ja võtab vähe ruumi.



⑤ Spetsiaalne segistite hooldusvahend

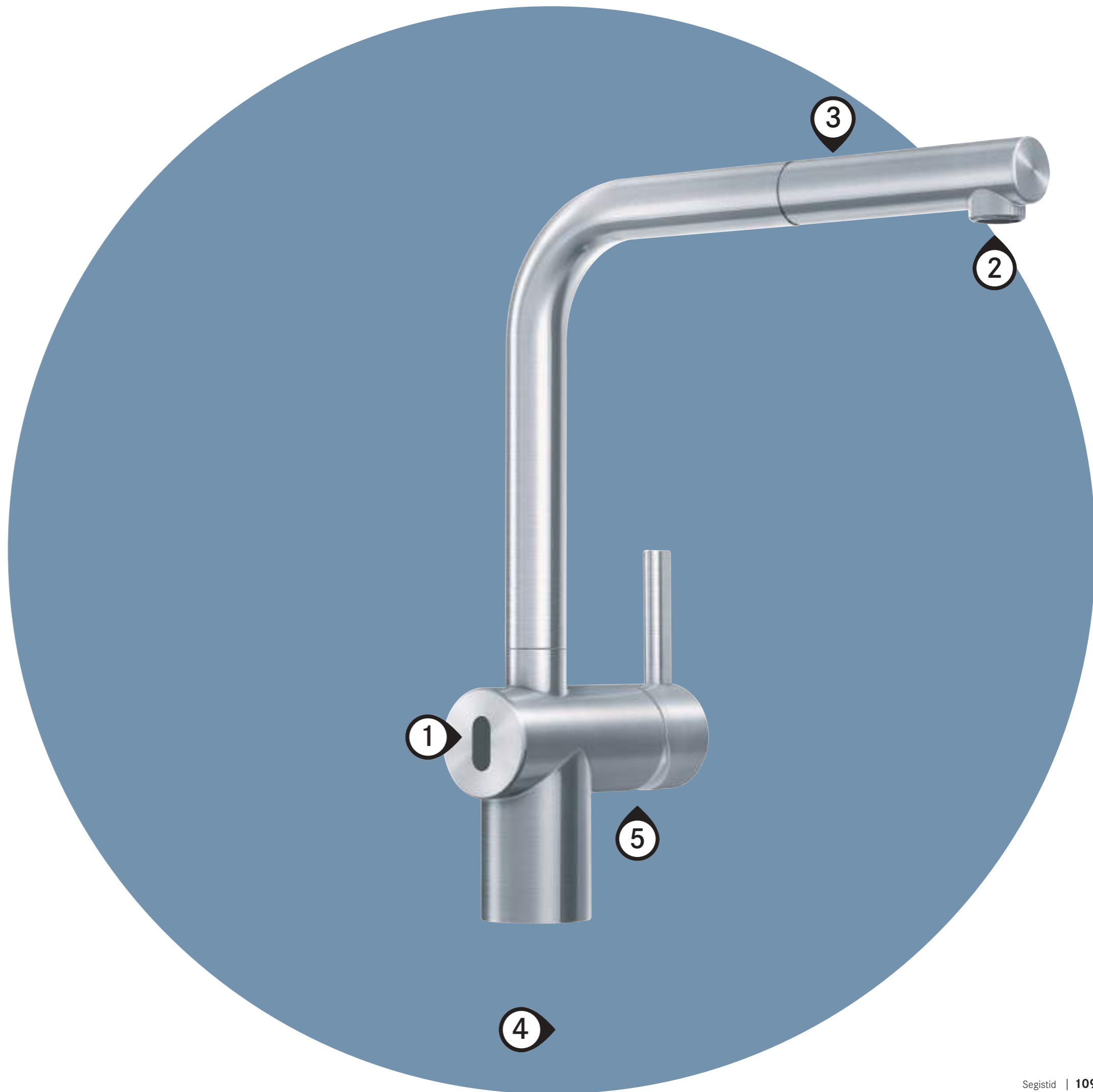

Segistid

Filtreeritud vee segistid filtriga ja ilma



Roostevabast terasest segistid



Kroomitud segistid



Kroomitud ja värvilised segistid



Segistid akna ette (painutatavad)





SEEBIDOSAATORID



SEGISTITE ÜLEVAADE



Seeria	Lk.	Väljatõmmatav	Dušš	Laminaarne vool	Filtersegi	Kang vasakul	Kang keskel	Kang paremal	Pöördeulat	Min. kaugus seinast mm	Segisti kõrgus mm	Väljavoolu kõrgus mm	Seeria	Lk.	kroom	Roostevaba teras	Roostevaba terase värv	Tõstuslik must	must matt	polaarvalge matt	polaarvalge	beež	cashmere	kivihall	grafit	onyx	Pronks	Vask	gunmetal
Vital	115	●	●		●		●	●	360°	-	477-550	260-303	Vital	115	●	●		●										●	
Mondial	117				●		●	●	360°	-	330	276	Mondial	117		●													
Atlas Neo Sensor	119	●		●			●	●	180°	-	297	270	Atlas Neo Sensor	119		●		●											
Wellfresh 110	121				●		●	●	360°	60	290	257	Wellfresh 110	121		●													
Wellfresh 150	121				●	●	●	●	360°	-	288	201	Wellfresh 150	121		●													
Atlas Neo	122	●	●	●			●	●	180°	-	297-299	247-270	Atlas Neo	122		●		●											
Tango Neo	124	●	●	●			●		120° - 150°	-	275	181-208	Tango Neo	124		●													
Kubus	126	●		●			●	●	180°	-	330-379	228-255	Kubus	126		●													
Eos Neo	127	●	●	●			●	●	180°	-	387-433	211-238	Eos Neo	127		●													
Mythos	128	●		●		●	●	●	360°	80	317-348	298-315	Mythos	128		●		●											
Pescara XL, L	129	●	●				●	●	360°	-	420-550	156-181	Pescara XL, L	129		●													
Orbit	130	●		●			●	●	120° - 360°	-	208-209	139-152	Orbit	130		●													
Taros Neo	131	●		●			●	●	120°	-	226	165	Taros Neo	131		●													
Pescara 360	132	●	●				●	●	360°	-	460	213	Pescara 360	132	●				●										
Pescar Up&Down	132		●				●	●	360°	-	435	260	Pescar Up&Down	132					●										
Flexus-S Jet	133	●	●				●	●	360°	-	507	210	Flexus-S Jet	133	●														
Maris J-Spout	133	●		●			●	●	360°	-	411	230	Maris J-Spout	133	●		●												
Icon	134	●	●	●			●	●	120° - 360°	-	341-355	260-261	Icon	134	●				●										
Lift	135	●	●	●			●	●	120° - 150°	-	289	174-199	Lift	135	●				●										
Active Plus	136	●	●				●	●	360°	-	310	280	Active Plus	136					●	●						●			
Active Plus	137	●				●	●	●	360°	70	310	280	Active Plus	137	●					●		●	●	●	●				
Maris	138	●	●	●			●	●	360°	-	290-295	259-261	Maris	138	●		●			●		●	●	●	●				
Neptune Evo	139	●				●	●	●	360°	60	290-291	260-261	Neptune Evo	139	●				●	●									
Orbit	140	●					●	●	120° - 360°	-	211	142	Orbit	140	●					●	●		●	●	●				
Centro	141	●		●			●	●	120° - 150°	-	278	154-162	Centro	141	●				●		●		●	●	●				
Urban	142	●					●	●	150° - 360°	-	294-306	250-259	Urban	142	●					●		●	●	●	●				
Novara Plus	143	●	●				●	●	120° - 360°	-	175-184	125-158	Novara Plus	143	●					●	●	●	●	●	●				
Lina Semi Pro	144	●	●				●	●	150°	-	410	140	Lina Semi Pro	144	●					●		●		●	●				
Lina XL	144						●	●	360°	-	350	220	Lina XL	144	●					●	●	●	●	●	●				
Lina L	145						●	●	360°	-	330	215	Lina L	145	●		●												
Lina	145	●					●	●	150°	-	360	185	Lina	145	●					●	●	●	●	●	●				
Smart	146	●	●				●	●	110° - 360°	-	201-225	140-154	Smart	146	●		●												
Samoa	147					●	●	●	360°	70	279	257	Samoa	147	●		●												
650	147					●	●	●	360°	50	328	212	650	147	●		●												
Sirius	148	●					●	●	360°	80	330	310	Sirius	148	●					●	●	●	●	●	●				
Old England	148						●	●	360°	45	290	209	Old England	148	●									●		●	●		
Window 													Window 																
Atlas Neo Window	149	●		●			●	●	180°	-	297	270	Atlas Neo Window	149		●													
Taros Neo Window	149	●		●			●	●	120°	-	226	165	Taros Neo Window	149		●													



Nagu väike ime...

Meie veefilter pole mitte maailma kõige väiksem, vaid ka esimene, millel on aktiivsüsi kombineeritud bionilise membraaniga. Tuletatud loodusest, välja töötatud Šveitsis.

1. EELFILTER

Eelfilter on esimene kaitseliin, kus suuremad osakesed välja filtreeritakse.

2. MEMBRAAN

Nanotehnoloogia teeb selle võimalikuks: 0.06 mm paksune membraan, suletud peenese nailonvõrku, filtreerib isegi bakterid joogiveest välja.

3. AKTIVEERITUD SÕEFILTER

Aktiveeritud süsi eemaldab lahustunud ained (näiteks kloori). See tehnoloogia on loomulik füüsikaline protsess, mis on end tõestanud.

4. VEEVOOL

Esmalt läbi eelfiltri, siis läbi membraani, lõpuks läbi aktiveeritud sõe ja filtreerituna otse klaasi. Franke väldib filtreeritud ja mittefilteritud vee teine-teisega kokkupuutumist.

VAHETUS

Kui LED valgusti muutub punaseks, siis tuleb filter ära vahetada.

Kätkeb endas palju eeliseid



Eemaldab 99.9999% baktereid



Eemaldab 99% viiruseid



Filtreerib välja rooste ja sette



Filtreerib välja mikroplastid



Eemaldab ebameeldiva maitse ja lõhna



Sobilik joogiks



Lihne kasutada
Filtreerib kuni 500 L



Ise desinfitseeruv



Keskonda säästev - säästab 500 l plastpudelit

Segisti süsteem VITAL koos filterkapsliga

Lisad

1 112.0607.497
Vital segisti filter
500L
€ 34,70



2 112.0607.498
Vital segisti filtrikomplekt
(komplektis 3 filterkapslit)
500L x3
€ 96,50



Mudel **VITAL**
Segisti mudel **Kombineeritud filtreeritud ja kuuma / külma vee jaoks**
Vee väljavool **fikseeritud otsikuga pööratava tilaga**
Pöördenurk **360°**
Laminaarne vool **Jah**
Segisti kang **kang paremal**
Filtreeritud vee kang **Kang üleval**
Veevool **12,5 L/min (3 bar)**
Filtri Veevool **3,5 L/min (3 bar)**
Ühendustorud **420 mm**
Filtreeritava vee maht **500 L**

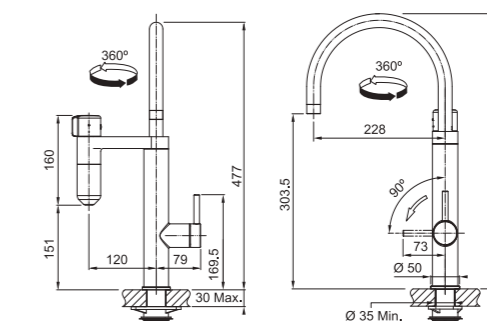

Värv	Artikkel	Hind €
kroom /Gunmetal	120.0551.218	522,00
tööstuslik must / roostevaba teras	120.0551.241	591,00



Mudel **VITAL**
Segisti mudel **Kombineeritud filtreeritud ja kuuma / külma vee jaoks**
Vee väljavool **väljatõmmatava dušiga / normaalse vooluga (lülitiga)**
Pöördenurk **360°**
Segisti kang **kang paremal**
Filtreeritud vee kang **Kang üleval**
Veevool **8 L/min (3 bar)**
Filtri Veevool **3,5 L/min (3 bar)**
Ühendustorud **420 mm**
Filtreeritava vee maht **500 L**

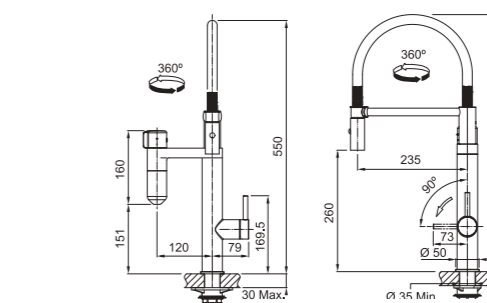

Värv	Artikkel	Hind €
kroom /Gunmetal	120.0551.219	728,00
tööstuslik must / roostevaba teras	120.0551.242	827,00



Mudel **VEEJAHUTI**
Boilera Maht **2,5 L**
Mõõdud **200 x285 x 345 mm**
Energijas pateriinš gadā **62 kWh**
Trokšņu līmenis **36 dB (A)**
Erimārkused **Kompaktne veejahuti, sobib tavalise aluskapi jaoks**

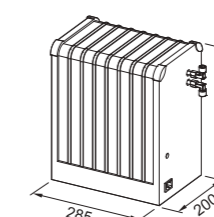

Värv	Artikkel	Hind €
valge/must plastik	120.0565.053	602,00

Väljavool
Kuum, külm ja filtreeritud vesi voolab torust, mida saab pöörata 360°. Materjal on kuumuse eest kaitstud, nii et saad seda alati hõlsalt käsitseda lahtise kraaniga.

YouTube
FrankeKitchenSystems

Väga lihtne ja lapsel ohutu Franke kuuma vee segisti kasutamine on intuitiivne ja pakub rohkem turvalisust, eriti väikeste kokkade jaoks. Sõltuvalt variandist annab segisti hoob või nupp ja nupp koos LED-tuledega täpselt soovitud vee.

Ooterežiim

Filtreeritud vesi

Keev vesi

Puhke režiim
Kui te ei võta pikka aega vett, lülitub boiler automaatselt puhkeolekusse ja soojendab ainult vett temperatuurini 45 ° C. Teatavate intervallidega soojeneb vesi uuesti 100 ° C-ni.

Franke Pro M Filter
Eemaldab ebameeldiva maitse ja lõhna nagu kloor, vähendab kahjulikke lisandeid, kuid säilitab olulised mineraalid vees. Lisaks vähendab see vee karedust ja kaitseb katlakivi eest. Filter vahetatakse iga 6-9 kuu tagant - olenevalt vee tarbimisest ja vee karedusest.



MONDIAL kombineeritud segisti keeva veega ja sooja / külma veega variandiga ühes korpuses

Lisad

1 120.0305.558

Filter cartridge PRO M
€ 99,40



Mudel	Värv	Artikkel	Hind €
Mudel Mondial Segisti mudel Kombineeritud keeva, filtreeritud, kuuma / külma vee jaoks Vee väljavool fikseeritud otsikuga pööratava tilaga Pöördnurk 360° Segisti kang kang paremal Filtreeritud vee kang kang vasakul Veevool 12,2 L/min (3 bar) Paagi maht 4,7 L Ühendustorud 800 mm Filtreeritava vee maht 1700 L	Roostevaba teras	119.0480.690	1910,00

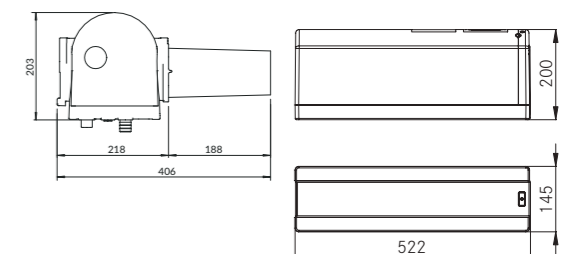
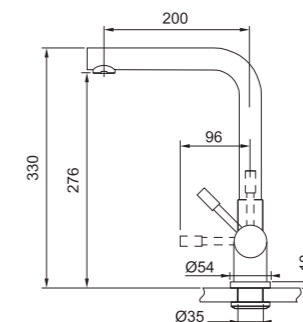



Roostevabast terasest veesegistid ATLAS NEO SENSOR anduri ja tavapärase juhtimisega

Mudelid on saadaval nii väljatõmmatava kui ka fikseeritud otsikuga. Roostevaba teras on kergesti hooldatav ja hügieeniliselt ohutu. Võib valida kriimustuskindla tööstuslikult musta kattega segisti.

M24 laminaarne aeraator vähendab pritsmeid ja muudab vee voolumise ühtlaseks.

Andurite abil juhtimine parandab köögihügieeni, kuna saame vett sageli kasutada ilma segistit füüsiliselt puudutamata.

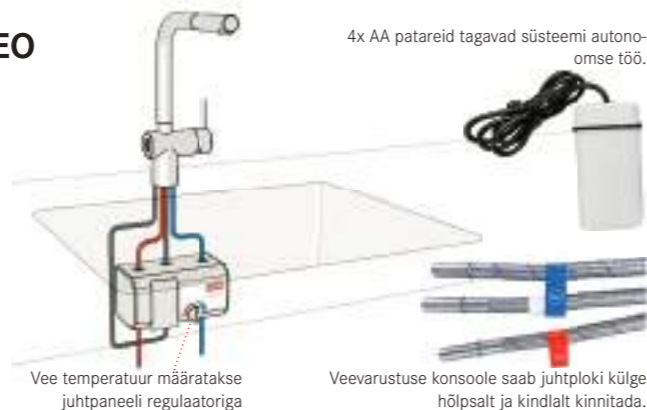

ANDURI JUHTIMINE

Liigutades oma käe 6 cm või lähemale vasakule küljele asuva anduri juurde ja vesi hakkab voolama 1 sekundi pärast. 30 sekundi pärast vool peatub. Vee temperatuur määratakse juhtnupu nupuga. Selle toiteallikaks on neli AA patareid, mis muudab süsteemi sõltumatuks. See säästab vett, kuna lülitame veevarustuse välja sageli hiljem kui vaja.

KANGIGA JUHTIMINE

Paremal küljel on kang, mille abil saab veevarustust tavapärasel viisil reguleerida. Keraamiline tööosa tagab pikaks ajaks ohutu töötamise.



ATLAS NEO SENSOR roostevabast terasest segistid sensoriga ja tavalise juhtimisega

Mudel	ATLAS NEO SENSOR	Värv	Artikkel	Hind €
Segisti mudel	Sensori ja käsitsi juhtimisega köögisegisti	Roostevaba teras	115.0625.523	468,00
Vee väljavool	väljatõmmatava otsikuga	tööstuslik must	115.0625.527	537,00
Pöördenurk	180°			
Materjal	Roostevaba teras			
Segisti kang	kang paremal			
Veevool	9 L/min (3 bar)			
Ühendustorud	450 mm			
Laminaarne vool	Jah			
Komplektis	Juhtimiseseade koos 4 AA 1,5 V patareiga (komplektis)			
Anduri töö	Anduriga sisselülitamisel seiskub veevool automaatselt 30 sekundi pärast			

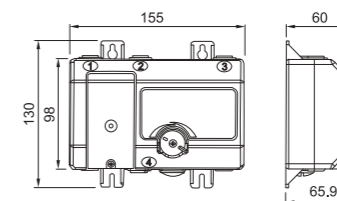
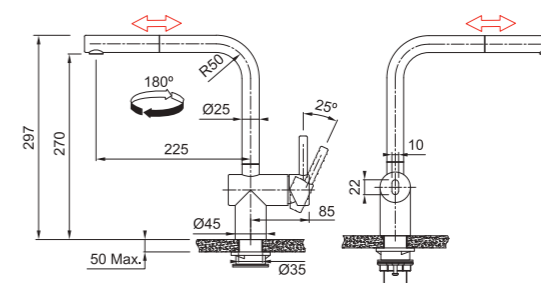

Mudel	ATLAS NEO SENSOR	Värv	Artikkel	Hind €
Segisti mudel	Sensori ja käsitsi juhtimisega köögisegisti	Roostevaba teras	115.0625.489	390,00
Vee väljavool	fikseeritud otsikuga pööratava tilga	tööstuslik must	115.0625.525	468,00
Pöördenurk	180°			
Materjal	Roostevaba teras			
Segisti kang	kang paremal			
Veevool	12,2 L/min (3 bar)			
Ühendustorud	450 mm			
Laminaarne vool	Jah			
Komplektis	Juhtimiseseade koos 4 AA 1,5 V patareiga (komplektis)			
Anduri töö	Anduriga sisselülitamisel seiskub veevool automaatselt 30 sekundi pärast			

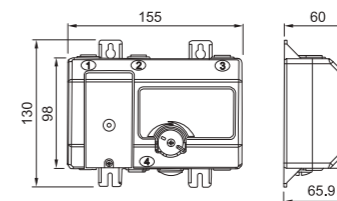
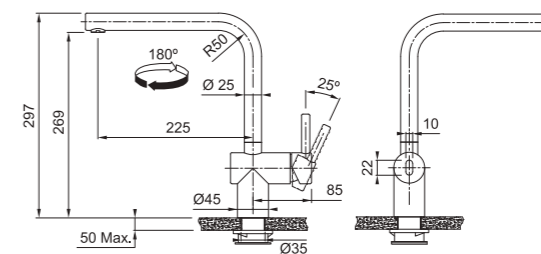



WELLFRESH roostevabast terasest segisti filtersüsteemiga

Mudel	Wellfresh 110	Värv	Artikkel	Hind €
Segisti mudel	Kombineeritud filtreeritud ja kuuma / külma vee jaoks	Roostevaba teras	120.0179.563	332,00
Vee väljavool	fikseeritud otsikuga pööratava tilaga			
Pöördnurk	360°			
Segisti kang	kang paremal			
Filtreeritud vee kang	kang vasakul			
Veevool	11,7 L/min (3 bar)			
Filtra Veevool	5,9 L/min (3 bar)			
Ühendustorud	800 mm			
Filtreeritava vee maht	1000 L			
Erimärkused	Komplektis Brita P1000 filter koos filtrihoidjaga			

Sisaldub komplektis



1. Mehaaniline filter püüab kinni suured osad
2. Soodium ioonfilter: pehmendab vett, kõrvaldab magneesiumi ja rasked metallid (seatina ja vase). Samas jäävad kasulikud mineraalid vette alles.
3. Hõbeioon antibakteriaalne aktiivsõefilter: mõjusalt blokeerib orgaanilised osad, kloori, pestitsiidid ja kõrvaldab ebameeldiva lõhna.
4. Lõpufilter: blokeerib kõik osakesed, mis tekkisid filtreerimise käigus

Lihne ja kiire filtri vahetamine



1. Keera kangi, et vabastada lukusti
2. Eemalda vana filterpadrun filtri peast
3. Aseta uus filterpadrun filtri peasse.
4. Lukusta kangi pööramisega filterpadrun.
5. Aktiveeri taimer valides meeldetuletuse 90 või 180 päeva möödumisel.

Mudel	Wellfresh 150	Värv	Artikkel	Hind €
Segisti mudel	Filtreeritud vee segisti	Roostevaba teras	120.0179.564	174,00
Vee väljavool	fikseeritud otsikuga pööratava tilaga			
Pöördnurk	360°			
Filtreeritud vee kang	kang paremal/vasakul			
Filtra Veevool	5,8 L/min (3 bar)			
Ühendustorud	1000 mm			
Filtreeritava vee maht	1000 L			
Erimärkused	Komplektis Brita P1000 filter koos filtrihoidjaga			

Sisaldub komplektis



ATLAS NEO roostevabast terasest segistid



Mudel **ATLAS NEO**
 Segisti mudel **Köögisegisti**
 Vee väljavool **väljatõmmatava dušiga / normaalse vooluga (lülitiga)**
 Pöördnurk **180°**
 Materjal **Roostevaba teras**
 Segisti kang **kang paremal**
 Veevool **8 L/min (3 bar)**
 Ühendustorud **450 mm**
 Erimärkused **Silikoondušši katlakivi vastane toime**
Radiaalne lihvimine

Värv	Artikkel	Hind €
	Roostevaba teras 115.0521.441	271,00

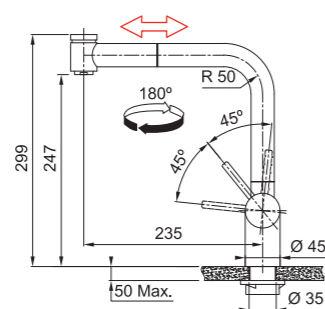

ATLAS NEO roostevabast terasest segistid



Mudel **ATLAS NEO**
 Segisti mudel **Köögisegisti**
 Vee väljavool **fikseeritud otsikuga pööratava tilaga**
 Pöördnurk **180°**
 Materjal **Roostevaba teras**
 Segisti kang **kang paremal**
 Laminaarne vool **Jah**
 Veevool **12,2 L/min (3 bar)**
 Ühendustorud **450 mm**
 Erimärkused **Radiaalne lihvimine**

Värv	Artikkel	Hind €
	Roostevaba teras 115.0521.435	213,00
	tööstuslik must 115.0550.424	255,00

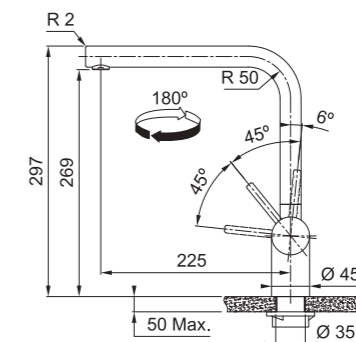

Mudel **ATLAS NEO**
 Segisti mudel **Köögisegisti**
 Vee väljavool **väljatõmmatava otsikuga**
 Pöördnurk **180°**
 Materjal **Roostevaba teras**
 Segisti kang **kang paremal**
 Laminaarne vool **Jah**
 Veevool **9 L/min (3 bar)**
 Ühendustorud **450 mm**
 Erimärkused **Radiaalne lihvimine**

Värv	Artikkel	Hind €
	Roostevaba teras 115.0521.438	256,00
	tööstuslik must 115.0550.427	307,00

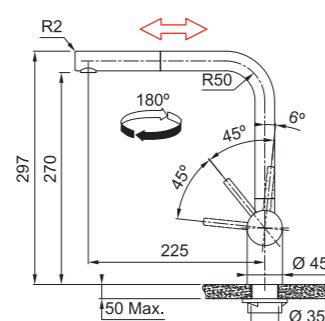

 Tavaline voolu aeraator
 133.0308.583
 € 4,50

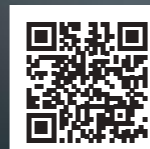

 Tavaline voolu aeraator
 133.0308.583
 € 4,50



TANGO NEO roostevabast terasest segistid



UUDIS



Mudel **TANGO NEO**
 Segisti mudel **Köögisegisti**
 Vee väljavool **väljatõmmatava dušiga / normaalse vooluga (lülitiga)**
 Pöördnurk **120°**
 Materjal **Roostevaba teras**
 Segisti kang **Kang üleval**
 Veevool **8 L/min (3 bar)**
 Vee säästurežiim **Jah**
 Ühendustorud **450 mm**
 Erimärkused **Silikoondušši katlakivi vastane toime**
Radiaalne lihvimine

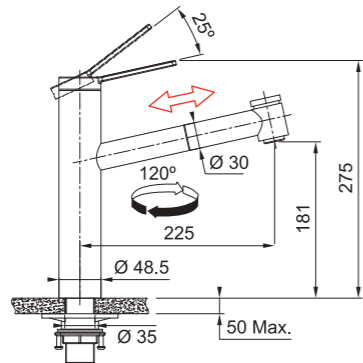

Vee säästurežiim

Värv	Artikkel	Hind €
●	Roostevaba teras 115.0596.389	348,00



TANGO NEO roostevabast terasest segistid



UUDIS



Mudel **TANGO NEO**
 Segisti mudel **Köögisegisti**
 Vee väljavool **fikseeritud otsikuga pööratava tilaga**
 Pöördnurk **150°**
 Materjal **Roostevaba teras**
 Segisti kang **Kang üleval**
 Laminaarne vool **Jah**
 Veevool **12 L/min (3 bar)**
 Vee säästurežiim **Jah**
 Ühendustorud **450 mm**
 Erimärkused **Radiaalne lihvimine**

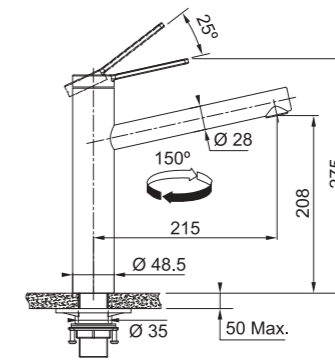

Vee säästurežiim

Värv	Artikkel	Hind €
●	Roostevaba teras 115.0596.387	266,00



UUDIS



Mudel **TANGO NEO**
 Segisti mudel **Köögisegisti**
 Vee väljavool **väljatõmmatava otsikuga**
 Pöördnurk **120°**
 Materjal **Roostevaba teras**
 Segisti kang **Kang üleval**
 Laminaarne vool **Jah**
 Veevool **9 L/min (3 bar)**
 Vee säästurežiim **Jah**
 Ühendustorud **450 mm**
 Erimärkused **Radiaalne lihvimine**

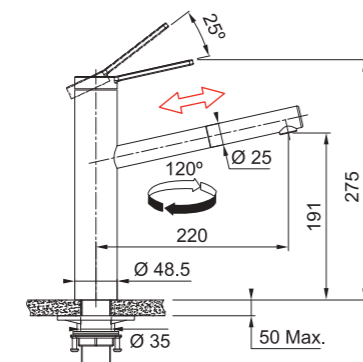

Vee säästurežiim

Värv	Artikkel	Hind €
●	Roostevaba teras 115.0596.388	319,00





KUBUS roostevabast terasest segistid



Mudel **KUBUS**
 Segisti mudel **Köögisegisti**
 Vee väljavool **väljatõmmatava otsikuga**
 Pöördenurk **180°**
 Materjal **Roostevaba teras**
 Segisti kang **kang paremal**
 Väljatõmmatav voolik **spetsiaalne kate - vaikne kasutuses**
 Veevool **10,5 L/min (3 bar)**
 Ühendustorud **450 mm**

Värv	Artikkel	Hind €
●	Roostevaba teras 115.0529.207	270,00

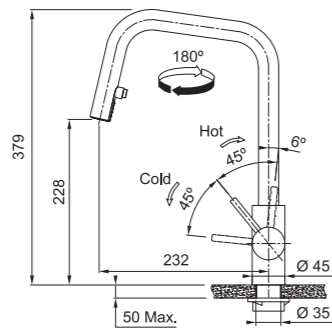

Mudel **KUBUS**
 Segisti mudel **Köögisegisti**
 Vee väljavool **fikseeritud otsikuga pööratava tilaga**
 Pöördenurk **180°**
 Laminaarne vool **Jah**
 Materjal **Roostevaba teras**
 Segisti kang **kang paremal**
 Veevool **12,7 L/min (3 bar)**
 Ühendustorud **450 mm**

Värv	Artikkel	Hind €
●	Roostevaba teras 115.0529.202	222,00

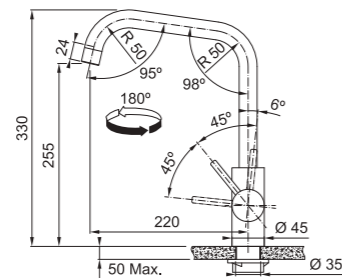

EOS-NEO roostevabast terasest segistid



Mudel **EOS-NEO**
 Segisti mudel **Köögisegisti**
 Vee väljavool **väljatõmmatava dušiga / normaalse vooluga (lülitiga)**
 Pöördenurk **180°**
 Materjal **Roostevaba teras**
 Segisti kang **kang paremal**
 Väljatõmmatav voolik **spetsiaalne kate - vaikne kasutuses**
 Veevool **9,3 L/min (3 bar)**
 Ühendustorud **450 mm**

Värv	Artikkel	Hind €
●	Roostevaba teras 115.0590.045	270,00

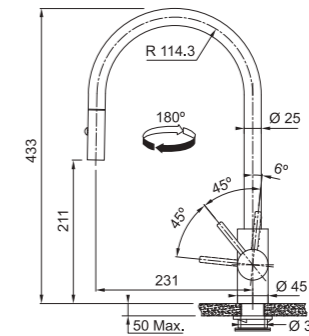

Mudel **EOS-NEO**
 Segisti mudel **Köögisegisti**
 Vee väljavool **fikseeritud otsikuga pööratava tilaga**
 Pöördenurk **180°**
 Laminaarne vool **Jah**
 Materjal **Roostevaba teras**
 Segisti kang **kang paremal**
 Veevool **14 L/min (3 bar)**
 Ühendustorud **450 mm**

Värv	Artikkel	Hind €
●	Roostevaba teras 115.0590.044	222,00

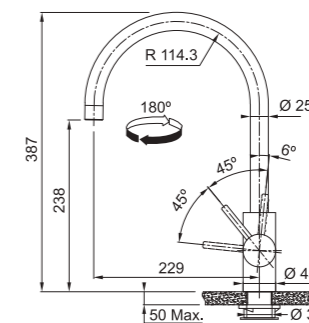



MYTHOS roostevabast terasest segistid

Mudel	Värv	Artikkel	Hind €
MYTHOS Segisti mudel Köögisegisti Vee väljavool väljatõmmatava otsikuga Pöördenurk 360° Materjal Roostevaba teras Segisti kang kang paremal/vasakul Veevool 9 L/min (3 bar) Ühendustorud 450 mm Minimaalne kaugus 80 mm segisti keskelt seinani	● Roostevaba teras	115.0547.853	345,00
	● tööstuslik must	115.0550.442	384,00

Mudel	Värv	Artikkel	Hind €
MYTHOS Segisti mudel Köögisegisti Vee väljavool fikseeritud otsikuga pööratava tilaga Pöördenurk 360° Materjal Roostevaba teras Segisti kang kang paremal/vasakul Veevool 12,5 L/min (3 bar) Ühendustorud 450 mm Minimaalne kaugus 80 mm segisti keskelt seinani Laminaarne vool Jah	● Roostevaba teras	115.0547.852	284,00
	● tööstuslik must	115.0550.441	315,00



PESCARA XL ja PESCARA L roostevabast terasest segistid

Mudel	Värv	Artikkel	Hind €
PESCARA XL Segisti mudel Köögisegisti Vee väljavool väljatõmmatava dušiga / normaalse vooluga (lülitiga) Pöördenurk 360° Materjal Roostevaba teras Segisti kang kang paremal Veevool 8,2 L/min (3 bar) Duširežiimi vool 8,1 L/min (3 bar) Ühendustorud 420 mm	● Roostevaba teras	115.0472.959	380,00

Mudel	Värv	Artikkel	Hind €
PESCARA L Segisti mudel Köögisegisti Vee väljavool väljatõmmatava dušiga / normaalse vooluga (lülitiga) Pöördenurk 360° Materjal Roostevaba teras Segisti kang kang paremal Veevool 8,2 L/min (3 bar) Duširežiimi vool 8,1 L/min (3 bar) Ühendustorud 420 mm	● Roostevaba teras	115.0472.960	299,00



ORBIT roostevabast terasest segistid

Mudel **ORBIT**
 Segisti mudel **Köögisegisti**
 Vee väljavool **väljatõmmatava otsikuga**
 Pöördnurk **120°**
 Laminaarne vool **Jah**
 Materjal **Roostevaba teras**
 Segisti kang **Kang üleval**
 Väljatõmmatav voolik **spetsiaalne kate - vaikne kasutuses**
 Veevool **9 L/min (3 bar)**
 Ühendustorud **450 mm**

Värv	Artikkel	Hind €
	Roostevaba teras 115.0569.461	224,00

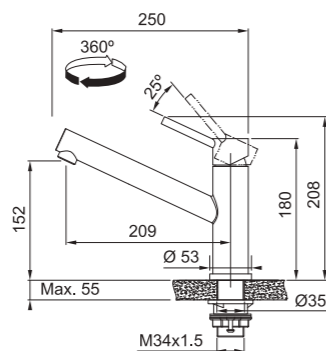
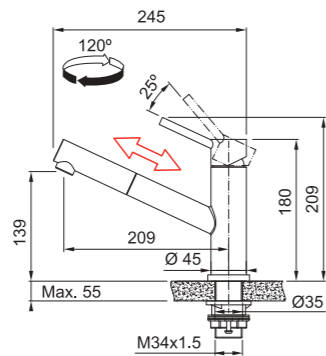

Mudel **ORBIT**
 Segisti mudel **Köögisegisti**
 Vee väljavool **fikseeritud otsikuga pööratava tilaga**
 Pöördnurk **360°**
 Laminaarne vool **Jah**
 Materjal **Roostevaba teras**
 Segisti kang **Kang üleval**
 Veevool **12,6 L/min (3 bar)**
 Ühendustorud **450 mm**

Värv	Artikkel	Hind €
	Roostevaba teras 115.0569.290	187,00



TAROS NEO roostevabast terasest segistid

Mudel **TAROS NEO**
 Segisti mudel **Köögisegisti**
 Vee väljavool **väljatõmmatava otsikuga**
 Pöördnurk **120°**
 Laminaarne vool **Jah**
 Materjal **Roostevaba teras**
 Segisti kang **Kang üleval**
 Väljatõmmatav voolik **spetsiaalne kate - vaikne kasutuses**
 Veevool **9 L/min (3 bar)**
 Vee säästurežiim **Jah**
 Ühendustorud **450 mm**

Värv	Artikkel	Hind €
	Roostevaba teras 115.0596.383	266,00



UUDIS

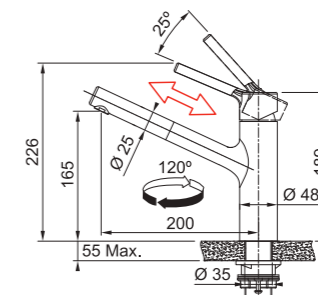

UUDIS



Mudel **TAROS NEO**
 Segisti mudel **Köögisegisti**
 Vee väljavool **fikseeritud otsikuga pööratava tilaga**
 Pöördnurk **120°**
 Laminaarne vool **Jah**
 Materjal **Roostevaba teras**
 Segisti kang **Kang üleval**
 Veevool **12 L/min (3 bar)**
 Vee säästurežiim **Jah**
 Ühendustorud **450 mm**

Värv	Artikkel	Hind €
	Roostevaba teras 115.0596.320	221,00

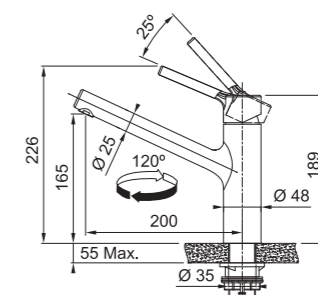



PESCARA 360, PESCARA UP & DOWN



Mudel **PESCARA 360°**
 Segisti mudel **Köögisegisti**
 Vee väljavool **väljatõmmatava dušiga / normaalse vooluga (lülitiga) dušš või tavaline juga**
 Pöördenurk **360°**
 Segisti kang **kang paremal**
 Veevool **8,2 L/min (3 bar)**
 Duširežiimi vool **8,1 L/min (3 bar)**
 Ühendustorud **450 mm**

Värv	Artikkel	Hind €
kroom	115.0393.976	472,00
Must matt	115.0545.136	522,00

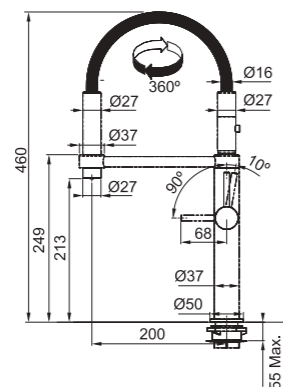

Mudel **PESCARA UP & DOWN**
 Segisti mudel **Köögisegisti**
 Vee väljavool **dušš või tavaline juga (vahetatav otsikut tõmmates)**
 Pöördenurk **360°**
 Segisti kang **kang paremal**
 Veevool **9 L/min (3 bar)**
 Ühendustorud **450 mm**

Värv	Artikkel	Hind €
Must matt	115.0545.135	394,00

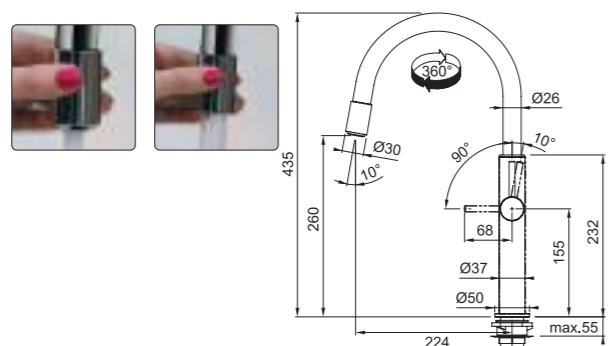

FLEXUS-S JET, MARIS J-SPOUT



Mudel **FLEXUS-S JET**
 Segisti mudel **Köögisegisti**
 Vee väljavool **väljatõmmatava dušiga / normaalse vooluga (lülitiga)**
 Pöördenurk **360°**
 Segisti kang **kang paremal/vasakul**
 Veevool **8 L/min (3 bar)**
 Ühendustorud **450 mm**
 Minimaalne kaugus segisti keskelt seinani **60 mm**
 Paigaldamine **Soovitame selle paigaldada töötasapinnale või graniidist valamule. RV valamule paigaldamisel tuleks kasutada segisti stabilisatorit 133.0026.896**

Värv	Artikkel	Hind €
kroom	115.0486.992	214,00

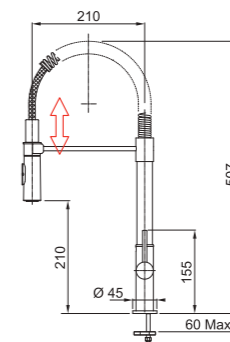

Mudel **MARIS J-SPOUT**
 Segisti mudel **Köögisegisti**
 Vee väljavool **väljatõmmatava otsikuga**
 Pöördenurk **360°**
 Laminaarne vool **Jah**
 Segisti kang **kang paremal**
 Veevool **8,1 L/min (3 bar)**
 Ühendustorud **450 mm**

Värv	Artikkel	Hind €
kroom	115.0523.195	203,00
roostevaba värv	115.0523.196	234,00

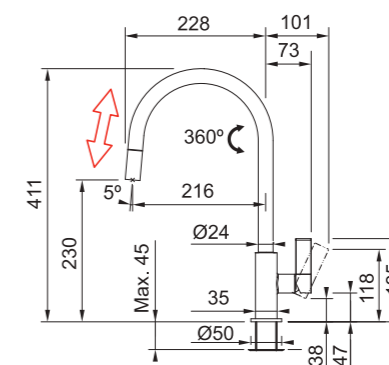



ICON



Mudel **ICON**
 Segisti mudel **Köögisegisti**
 Vee väljavool **väljatõmmatava dušiga / normaalse vooluga (lülitiga)**
 Pöördenurk **360°**
 Segisti kang **kang paremal**
 Väljatõmmatav voolik **spetsiaalne kate - vaikne kasutuses**
 Veevool **9 L/min (3 bar)**
 Laminaarne vool **Jah**
 Ühendustorud **450 mm**

Värv	Artikkel	Hind €
 kroom	115.0625.188	379,00
 Must matt	115.0625.190	479,00

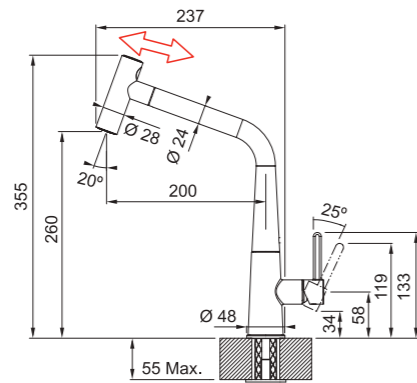



UUDIS
   360°

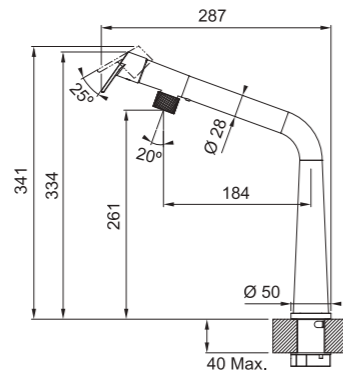

Mudel **ICON**
 Segisti mudel **Köögisegisti**
 Vee väljavool **fikseeritud otsikuga pööratava tilaga**
 Pöördenurk **120°**
 Segisti kang **Kang üleval**
 Veevool **12 L/min (3 bar)**
 Laminaarne vool **Jah**
 Ühendustorud **450 mm**

Värv	Artikkel	Hind €
 kroom	115.0625.185	290,00
 Must matt	115.0625.187	391,00



UUDIS
   120°



LIFT



Mudel **LIFT**
 Segisti mudel **Köögisegisti**
 Vee väljavool **väljatõmmatava dušiga / normaalse vooluga (lülitiga)**
 Pöördenurk **120°**
 Segisti kang **Kang üleval**
 Väljatõmmatav voolik **spetsiaalne kate - vaikne kasutuses**
 Veevool **9 L/min (3 bar)**
 Ühendustorud **450 mm**

Värv	Artikkel	Hind €
 kroom	115.0621.668	390,00
 Must matt	115.0621.670	491,00

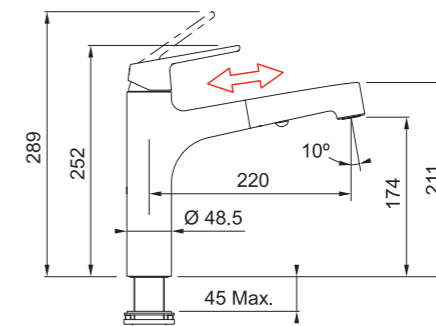

UUDIS
   120°



Mudel **LIFT**
 Segisti mudel **Köögisegisti**
 Vee väljavool **fikseeritud otsikuga pööratava tilaga**
 Pöördenurk **150°**
 Segisti kang **Kang üleval**
 Veevool **12 L/min (3 bar)**
 Laminaarne vool **Jah**
 Ühendustorud **450 mm**

Värv	Artikkel	Hind €
 kroom	115.0621.498	297,00
 Must matt	115.0621.667	398,00

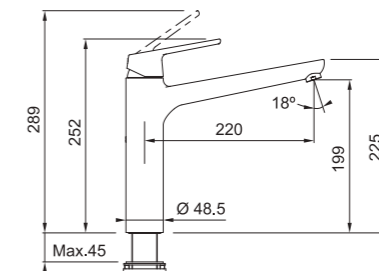

UUDIS
   150°



ACTIVE-PLUS



Mudel **ACTIVE-PLUS**
 Segisti mudel **Köögisegisti**
 Vee väljavool **väljatõmmatava dušiga / normaalse vooluga (lülitiga)**
Metallist väljatõmmatav otsik
 Pöördnurk **360°**
 Väljatõmmatav voolik **spetsiaalne kate - vaikne kasutuses**
 Segisti kang **kang paremal**
 Veevool **9,7 L/min (3 bar)**
 Vee säästurežiim **Jah**
 Ühendustorud **450 mm**
 Erimärkused **Silikoondušši katlakivi vastane toime**

Värv	Artikkel	Hind €
Valge matt	115.0524.931	305,00
Must matt	115.0524.890	305,00

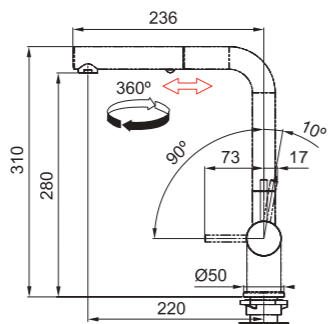

Mudel **ACTIVE-PLUS**
 Segisti mudel **Köögisegisti**
 Vee väljavool **fikseeritud otsikuga pööratava tilaga**
 Pöördnurk **360°**
 Segisti kang **kang paremal**
 Veevool **12,2 L/min (3 bar)**
 Vee säästurežiim **Jah**
 Ühendustorud **450 mm**

Värv	Artikkel	Hind €
Valge matt	115.0524.930	246,00
Must matt	115.0524.888	246,00
Pronks	115.0524.926	246,00

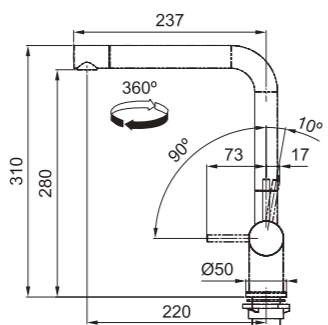

ACTIVE-PLUS



Mudel **ACTIVE-PLUS**
 Segisti mudel **Köögisegisti**
 Vee väljavool **väljatõmmatava otsikuga**
 Pöördnurk **360°**
 Väljatõmmatav voolik **spetsiaalne kate - vaikne kasutuses**
 Segisti kang **kang paremal/vasakul**
 Veevool **9,7 L/min (3 bar)**
 Ühendustorud **550 mm**
 Minimaalne kaugus **70 mm**
 segisti keskelt seinani

Värv	Artikkel	Hind €
kroom	115.0373.770	256,00
kroom/polaarvalge	115.0373.888	288,00
kroom/cashmere	115.0373.885	288,00
kroom/kivihall	115.0373.889	288,00
kroom/grafiit	115.0373.890	288,00
kroom/onyx	115.0373.901	288,00

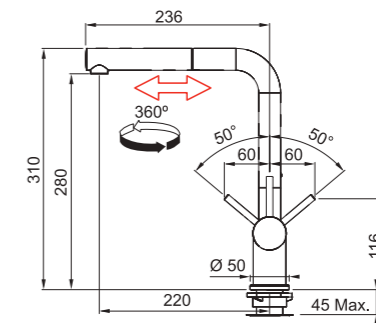

Mudel **ACTIVE-PLUS**
 Segisti mudel **Köögisegisti**
 Vee väljavool **fikseeritud otsikuga pööratava tilaga**
Pööratav aeraatori ots
 Pöördnurk **360°**
 Segisti kang **kang paremal/vasakul**
 Veevool **12,2 L/min (3 bar)**
 Ühendustorud **550 mm**
 Minimaalne kaugus **70 mm**
 segisti keskelt seinani

Värv	Artikkel	Hind €
kroom	115.0373.790	202,00
kroom/polaarvalge	115.0373.817	234,00
kroom/cashmere	115.0373.811	234,00
kroom/kivihall	115.0373.818	234,00
kroom/grafiit	115.0373.820	234,00
kroom/onyx	115.0373.821	234,00

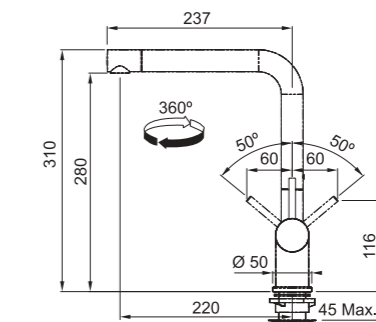



MARIS



Mudel **MARIS**
 Segisti mudel **Köögisegisti**
 Vee väljavool **väljatõmmatava dušiga / normaalse vooluga (lülitiga)**
 Pöördenurk **360°**
 Väljatõmmatav voolik **spetsiaalne kate - vaikne kasutuses**
 Segisti kang **kang paremal**
 Veevool **10 L/min (3 bar)**
 Duširežiimi vool **5,2 L/min (3 bar)**
 Ühendustorud **440 mm**
 Minimaalne kaugus segisti keskelt seinani **50 mm**

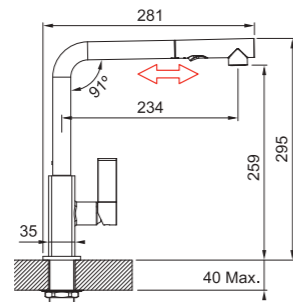

Värv	Artikkel	Hind €
kroom	115.0392.357	186,00
roostevaba värvi	115.0392.358	214,00
kroom/polaarvalge	115.0392.368	214,00
kroom/cashmere	115.0392.362	214,00
kroom/kivihall	115.0392.369	214,00
kroom/grafiit	115.0392.370	214,00
kroom/onyx	115.0392.382	214,00



NEPTUNE-EVO



Mudel **NEPTUNE-EVO**
 Segisti mudel **Köögisegisti**
 Vee väljavool **väljatõmmatava otsikuga**
 Pöördenurk **360°**
 Väljatõmmatav voolik **spetsiaalne kate - vaikne kasutuses**
 Segisti kang **kang paremal/vasakul**
 Veevool **9,5 L/min (3 bar)**
 Ühendustorud **450 mm**
 Minimaalne kaugus segisti keskelt seinani **60 mm**

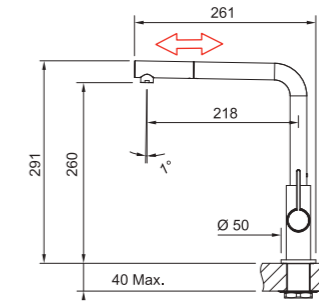

Värv	Artikkel	Hind €
kroom	115.0373.943	234,00
kroom/polaarvalge	115.0373.944	234,00
kroom /must	115.0373.945	234,00



Mudel **MARIS**
 Segisti mudel **Köögisegisti**
 Vee väljavool **fikseeritud otsikuga pööratava tilaga**
 Pöördenurk **360°**
 Laminaarne vool **Jah**
 Segisti kang **kang paremal**
 Veevool **10,1 L/min (3 bar)**
 Ühendustorud **450 mm**
 Minimaalne kaugus segisti keskelt seinani **50 mm**

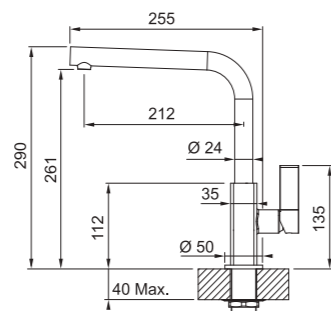

Värv	Artikkel	Hind €
kroom	115.0392.332	157,00
roostevaba värvi	115.0392.333	182,00
kroom/polaarvalge	115.0392.340	182,00
kroom/cashmere	115.0392.337	182,00
kroom/kivihall	115.0392.352	182,00
kroom/grafiit	115.0392.353	182,00
kroom/onyx	115.0392.356	182,00



Mudel **NEPTUNE-EVO**
 Segisti mudel **Köögisegisti**
 Vee väljavool **fikseeritud otsikuga pööratava tilaga**
 Pöördenurk **360°**
 Segisti kang **kang paremal/vasakul**
 Veevool **11,7 L/min (3 bar)**
 Ühendustorud **450 mm**
 Minimaalne kaugus segisti keskelt seinani **60 mm**

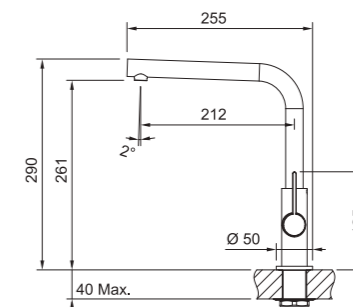

Värv	Artikkel	Hind €
kroom	115.0373.928	202,00
kroom/polaarvalge	115.0373.929	202,00
kroom /must	115.0373.930	202,00



ORBIT



UUDIS



Mudel **ORBIT**
 Segisti mudel **Köögisegisti**
 Vee väljavool **väljatõmmatava otsikuga**
 Pöördenuk **120°**
 Väljatõmmatav voolik **spetsiaalne kate - vaikne kasutuses**
 Segisti kang **Kang üleval**
 Veevool **9 L/min (3 bar)**
 Ühendustorud **450 mm**

Värv	Artikkel	Hind €
kroom	115.0623.055	118,00
kroom/polaarvalge	115.0623.139	139,00
kroom/kivihall	115.0623.141	139,00
kroom/grafiit	115.0623.134	139,00
kroom/onyx	115.0623.057	139,00

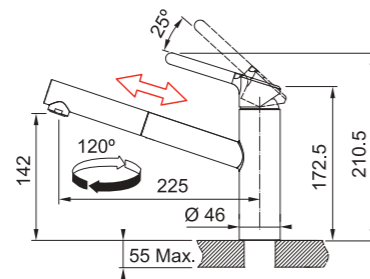

UUDIS



Mudel **ORBIT**
 Segisti mudel **Köögisegisti**
 Vee väljavool **fikseeritud otsikuga pööratava tilaga**
 Pöördenuk **360°**
 Segisti kang **Kang üleval**
 Veevool **12 L/min (3 bar)**
 Ühendustorud **450 mm**

Värv	Artikkel	Hind €
kroom	115.0623.054	100,00
kroom/polaarvalge	115.0623.137	118,00
kroom/beež	115.0623.135	118,00
kroom/kivihall	115.0623.140	118,00
kroom/grafiit	115.0623.132	118,00
kroom/onyx	115.0623.056	118,00

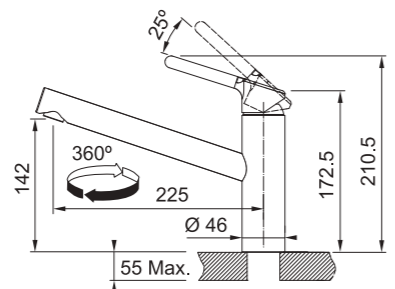

CENTRO



UUDIS



Mudel **CENTRO**
 Segisti mudel **Köögisegisti**
 Vee väljavool **väljatõmmatava otsikuga**
 Pöördenuk **120°**
 Väljatõmmatav voolik **spetsiaalne kate - vaikne kasutuses**
 Segisti kang **Kang üleval**
 Veevool **9 L/min (3 bar)**
 Laminaarne vool **Jah**
 Ühendustorud **450 mm**

Värv	Artikkel	Hind €
kroom	115.0600.098	201,00
kroom/polaarvalge	115.0621.549	241,00
kroom/cashmere	115.0621.594	241,00
kroom/kivihall	115.0621.548	241,00
kroom/onyx	115.0621.546	241,00
Must matt	115.0621.592	241,00

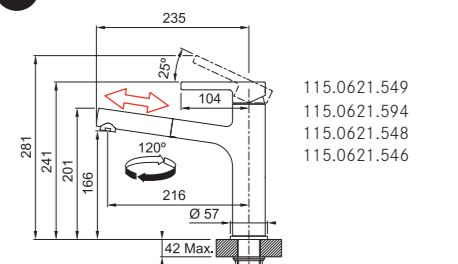
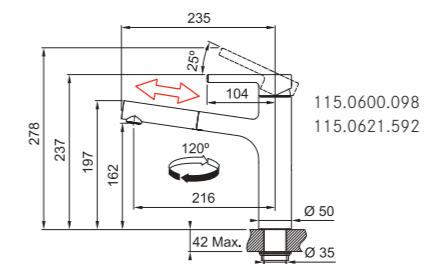

UUDIS



Mudel **CENTRO**
 Segisti mudel **Köögisegisti**
 Vee väljavool **fikseeritud otsikuga pööratava tilaga**
 Pöördenuk **150°**
 Segisti kang **Kang üleval**
 Veevool **12 L/min (3 bar)**
 Ühendustorud **450 mm**

Värv	Artikkel	Hind €
kroom	115.0600.095	170,00
kroom/polaarvalge	115.0621.600	204,00
kroom/cashmere	115.0621.615	204,00
kroom/kivihall	115.0621.599	204,00
kroom/onyx	115.0621.596	204,00
Must matt	115.0621.613	204,00

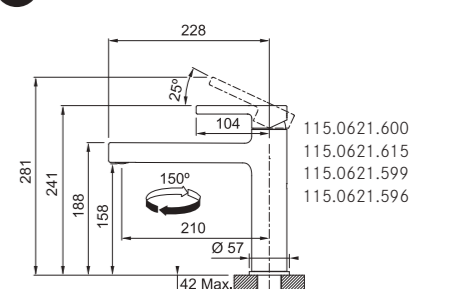
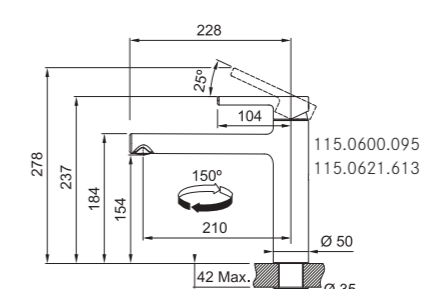



URBAN



Mudel **URBAN**
 Segisti mudel **Köögisegisti**
 Vee väljavool **väljatõmmatava otsikuga**
 Pöördenurk **150°**
 Väljatõmmatav voolik **spetsiaalne kate - vaikne kasutuses**
 Segisti kang **kang paremal**
 Veevool **10 L/min (3 bar)**
 Ühendustorud

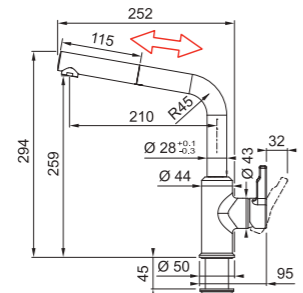

Värv	Artikkel	Hind €
kroom	115.0595.083	201,00
polaarvalge	115.0595.088	204,00
cashmere	115.0595.093	204,00
kivihall	115.0595.089	204,00
grafiit	115.0595.090	204,00
onyx	115.0595.091	204,00



Mudel **URBAN**
 Segisti mudel **Köögisegisti**
 Vee väljavool **fikseeritud otsikuga pööratava tilaga**
 Pöördenurk **360°**
 Segisti kang **kang paremal**
 Veevool **15 L/min (3 bar)**
 Ühendustorud

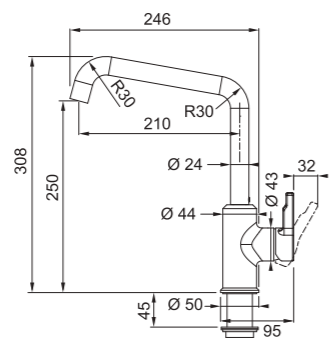

Värv	Artikkel	Hind €
kroom	115.0595.062	171,00
polaarvalge	115.0595.068	173,00
cashmere	115.0595.066	173,00
kivihall	115.0595.069	173,00
grafiit	115.0595.070	173,00
onyx	115.0595.081	171,00



NOVARA-PLUS



Mudel **NOVARA-PLUS**
 Segisti mudel **Köögisegisti**
 Vee väljavool **väljatõmmatava dušiga / normaalse vooluga (lülitiga)**
 Pöördenurk **120°**
 Väljatõmmatav voolik **spetsiaalne kate - vaikne kasutuses**
 Segisti kang **Kang üleval**
 Veevool **10,3 L/min (3 bar)**
 Duširežiimi vool **8,1 L/min (3 bar)**
 Ühendustorud **450 mm**

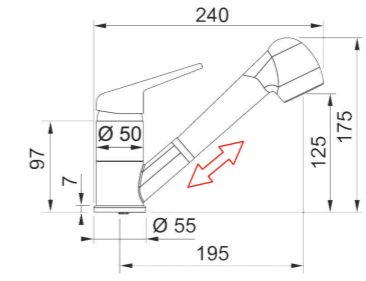

Värv	Artikkel	Hind €
kroom	115.0347.111	98,00
polaarvalge	115.0470.669	170,00
beež	115.0470.665	170,00
cashmere	115.0470.666	170,00
kivihall	115.0470.670	170,00
grafiit	115.0470.674	170,00
onyx	115.0470.675	170,00



Mudel **NOVARA-PLUS**
 Segisti mudel **Köögisegisti**
 Vee väljavool **fikseeritud otsikuga pööratava tilaga**
 Pöördenurk **360°**
 Segisti kang **Kang üleval**
 Veevool **16,3 L/min (3 bar)**
 Ühendustorud **450 mm**

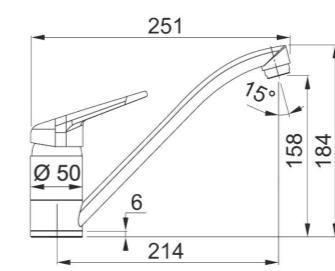

Värv	Artikkel	Hind €
kroom	115.0347.142	61,00
polaarvalge	115.0470.658	115,00
beež	115.0470.654	115,00
cashmere	115.0470.655	115,00
kivihall	115.0470.659	115,00
grafiit	115.0470.660	115,00
onyx	115.0470.661	115,00



LINA SemiPro , LINA XL



Mudel **LINA SEMI PRO**
 Segisti mudel **Köögisegisti**
 Vee väljavool **väljatõmmatava dušiga / normaalse vooluga (lülitiga)**
 Pöördnurk **150°**
 Segisti kang **kang paremal**
 Veevool **9 L/min (3 bar)**
 Ühendustorud **450 mm**

Värv	Artikkel	Hind €	
	kroom/polaarvalge*	115.0626.088	125,00
	kroom/kivihall*	115.0626.087*	125,00
	kroom/onyx*	115.0626.085*	125,00

* - saadaval alates 2021. aasta juunist

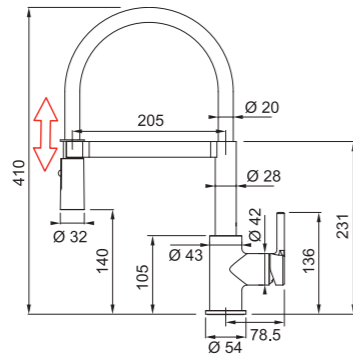

UUDIS



LINA L , LINA



Mudel **LINA L**
 Segisti mudel **Köögisegisti**
 Vee väljavool **fikseeritud otsikuga pööratava tilaga**
 Pöördnurk **360°**
 Segisti kang **kang paremal**
 Ühendustorud **450 mm**
 Veevool **12 L/min (3 bar)**

Värv	Artikkel	Hind €	
	kroom*	115.0625.988*	80,00
	roostevaba värvi*	115.0625.989*	94,00

* - saadaval alates maist 2021

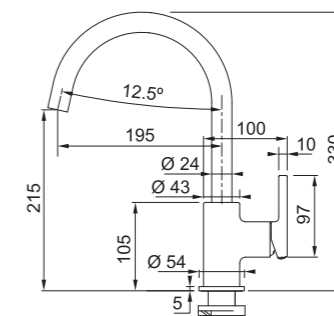

UUDIS



Mudel **LINA XL**
 Segisti mudel **Köögisegisti**
 Vee väljavool **fikseeritud otsikuga pööratava tilaga**
 Pöördnurk **360°**
 Segisti kang **kang paremal**
 Veevool **12 L/min (3 bar)**
 Ühendustorud **450 mm**

Värv	Artikkel	Hind €	
	kroom*	115.0626.018*	87,00
	polaarvalge*	115.0626.024*	97,00
	beež*	115.0626.026*	97,00
	cashmere*	115.0626.028*	97,00
	kivihall*	115.0626.022*	97,00
	grafiit*	115.0626.021*	97,00
	onyx*	115.0626.020*	97,00

* - saadaval alates maist 2021

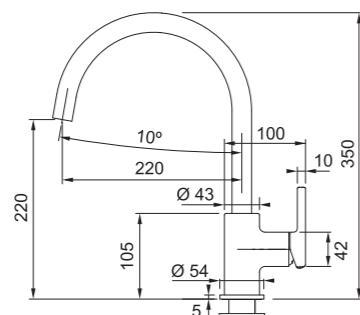

UUDIS



Mudel **LINA**
 Segisti mudel **Köögisegisti**
 Vee väljavool **väljatõmmatava otsikuga**
 Pöördnurk **150°**
 Segisti kang **kang paremal**
 Veevool **11 L/min (3 bar)**
 Ühendustorud **450 mm**

Värv	Artikkel	Hind €	
	kroom*	115.0626.051*	98,00
	polaarvalge*	115.0626.081*	106,00
	beež*	115.0626.083*	106,00
	cashmere*	115.0626.084*	106,00
	kivihall*	115.0626.057*	106,00
	grafiit*	115.0626.056*	106,00
	onyx*	115.0626.055*	106,00

* - saadaval alates maist 2021

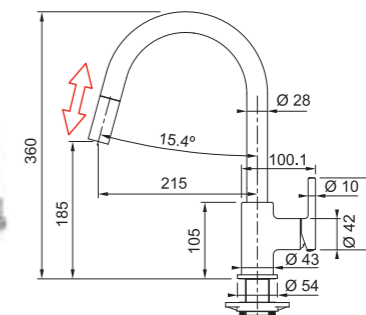

UUDIS





SMART

Mudel	SMART	Värv	Artikkel	Hind €
Segisti mudel	Köögisegisti	kroom	115.0391.482	157,00
Vee väljavool	väljatõmmatava dušiga / normaalse vooluga (lülitiga)			
Pöördenurk	110°			
Segisti kang	Kang üleval			
Väljatõmmatav voolik	spetsiaalne kate - vaikne kasutuses			
Veevool	9 L/min (3 bar)			
Duširežiimi vool	8,3 L/min (3 bar)			
Ühendustorud	420 mm			

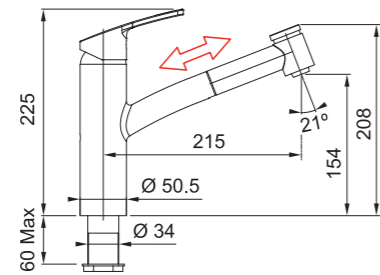

Mudel	SMART	Värv	Artikkel	Hind €
Segisti mudel	Köögisegisti	kroom	115.0391.460	94,00
Vee väljavool	fikseeritud otsikuga pööratava tilaga			
Pöördenurk	360°			
Segisti kang	Kang üleval	roostevaba värv	115.0391.481	136,00
Veevool	12,1 L/min (3 bar)			
Ühendustorud	510 mm			

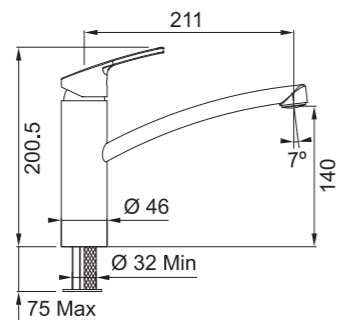

SAMOA, 650

Mudel	SAMOA	Värv	Artikkel	Hind €
Segisti mudel	Köögisegisti	kroom	115.0046.072	132,00
Vee väljavool	fikseeritud otsikuga pööratava tilaga			
Pöördenurk	360°			
Segisti kang	kang paremal/vasakul	roostevaba värv	115.0458.915	146,00
Ühendustorud	450 mm			
Minimaalne kaugus segisti keskelt seinani	70 mm			

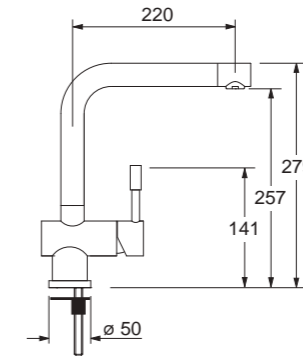

Mudel	650	Värv	Artikkel	Hind €
Segisti mudel	Köögisegisti	kroom*	115.0156.315*	80,00
Vee väljavool	fikseeritud otsikuga pööratava tilaga			
Pöördenurk	360°			
Segisti kang	kang paremal/vasakul	roostevaba värv*	115.0364.903*	94,00
Ühendustorud	450 mm			
Minimaalne kaugus segisti keskelt seinani	50 mm			

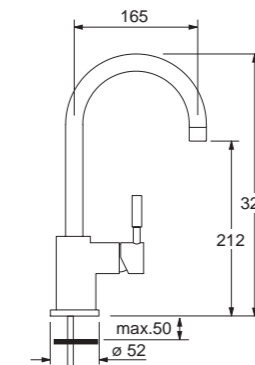

* - Saadaval kuni 2021. aasta maini



SIRIUS, OLD ENGLAND

	Mudel SIRIUS	Värv	Artikkel	Hind €
	Segisti mudel Köögisegisti	kroom	115.0476.760	100,00
	Vee väljavool väljatõmmatava otsikuga	kroom/polaarvalge	115.0476.826	108,00
	Pöördenurk 360°	kroom/beež	115.0476.822	108,00
	Väljatõmmatav voolik spetsiaalne kate - vaikne kasutuses	kroom/cashmere	115.0476.828	108,00
	Segisti kang kang paremal	kroom/kivihall	115.0476.824	108,00
	Minimaalne kaugus segisti keskelt seinani 80 mm	kroom/grafiit	115.0476.823	108,00
	Ühendustorud 440 mm	kroom/onyx	115.0476.827	108,00

	Mudel OLD ENGLAND	Värv	Artikkel	Hind €
	Segisti mudel Köögisegisti	kroom	115.0060.360	157,00
	Vee väljavool fikseeritud otsikuga pööratava tilaga	kroom/grafiit	115.0180.686	165,00
	Pöördenurk 360°	Pronks	115.0028.205	165,00
	Segisti kang kang paremal	Vask	115.0028.208	165,00
	Ühendustorud 350 mm			
	Minimaalne kaugus segisti keskelt seinani 45 mm			
	Aluse läbimõõt 56 mm			



ATLAS NEO WINDOW, TAROS NEO WINDOW

	Mudel ATLAS NEO WINDOW	Värv	Artikkel	Hind €
	Segisti mudel Köögisegisti täiendava võimalusega	Roostevaba teras	115.0521.439	277,00
	Vee väljavool väljatõmmatava otsikuga			
	Metallist väljatõmmatav otsik			
	Pöördenurk 180°			
	Materjal Roostevaba teras			
	Segisti kang kang paremal			
	Laminaarne vool Jah			
	Veevool 13 L/min (3 bar)			
	Ühendustorud 600 mm			
	Erimärkused Radiaalne lihvimine			

	Mudel TAROS NEO WINDOW	Värv	Artikkel	Hind €
	Segisti mudel Köögisegisti täiendava võimalusega	Roostevaba teras	115.0596.381	289,00
	Vee väljavool fikseeritud otsikuga pööratava tilaga			
	Pöördenurk 120°			
	Materjal Roostevaba teras			
	Segisti kang Kang üleval			
	Veevool 12 L/min (3 bar)			
	Vee säästurežiim Jah			
	Laminaarne vool Jah			
	Ühendustorud 750 mm			



SEEBIDOSAATORID

Mudel **NOVITA STEEL**
 Dozatora Mudel **Seebidosaat**
 Paigaldamine **Valamule või tööpinna**
 Täitke ülalt

Maht **250 ml**
 Roostevabast terasest valamute paigaldusavad
 Tööpinna paigaldusaugud **25 - 35 mm**

Värv

Värv	Artikkel	Hind €
Roostevaba teras	119.0177.893	173,00

Mudel **NOVITA**
 Dozatora Mudel **Seebidosaat**
 Paigaldamine **Valamule või tööpinna**
 Täitke ülalt

Maht **300 ml**
 Roostevabast terasest valamute paigaldusavad
 Tööpinna paigaldusaugud **25 - 35 mm**

Värv

Värv	Artikkel	Hind €
kroom	119.0150.262	72,00
roostevaba värvi	119.0155.993	91,00



Mudel **COMFORT**
 Dozatora Mudel **Seebidosaat**
 Paigaldamine **Valamule või tööpinna**
 Täitke ülalt

Maht **250 ml**
 Augud paigaldamiseks **25 mm**
35 mm

Värv

Värv	Artikkel	Hind €
kroom	119.0584.065	41,00
roostevaba värvi	119.0578.771	41,00
kroom/polaarvalge	119.0578.748	41,00
kroom/beež	119.0578.745	41,00
kroom/cashmere	119.0578.750	41,00
kroom/kivihall	119.0578.744	41,00
kroom/grafiit	119.0578.749	41,00
kroom/onyx	119.0578.743	41,00

Mudel **ACTIVE PLUS**
 Dozatora Mudel **Seebidosaat**
 Paigaldamine **Valamule või tööpinna**
 Täitke ülalt

Maht **300 ml**
 Augud paigaldamiseks **25 mm**
35 mm

Värv

Värv	Artikkel	Hind €
Valge matt	119.0547.905	96,00
Must matt	119.0547.906	96,00
kroom	119.0547.902	86,00
Pronks	119.0547.910	96,00

Sorterid



Täiuslik kord isegi sorteerimissüsteemis.



Kõik üksikasjad tootes, mis on loodud hõlpsasti puhastatavaks ja hügieeniliseks.



Paindlik sorteerimismahutite süsteem.



Sahtel puhastustoodete jaoks on samal ajal mahutite kate ja varustatud lõhnade vähendamiseks aktiivsöefiltriga.



Lihtne paigaldada spetsiaalsete šabloonide abil. Lihtne reguleerimine igapäevase kasutamise ajal.

Sorterid aluskapi laiuse järgi

60 cm



FX
60 cm
154. lk.



GARBO 60-4
60 cm
155. lk.



GARBO 60-3
60 cm
155. lk.



GARBO 60-2
60 cm
153. lk.



EASYSORT 60
60 cm
154. lk.

50 cm



GARBO 50-3
50 cm
156. lk.



CUBE 50
50 cm
156. lk.

45 cm



GARBO 45-2
45 cm
156. lk.



EASYSORT 45
45 cm
156. lk.

40 cm



CUBE 40
40 cm
157. lk.



SORTER PIVOT
40 cm
157. lk.



SORTER MINI
40 cm
157. lk.

30 cm



CUBE 30
30 cm
158. lk.

Nurga sorterid



CUBE CORNER
158. lk.



Sorterid aluskapile 60 cm



Mudel	Maht	Artikkel	Hind €
FX-60 Aluskapp 60 cm Mõõdud 600 x 456 x 448 mm Sorteri tüüp Esiuksega avatav Paigaldamine Kinnitatakse külgsseite külge lihtne paigaldada, šabloon kaasas Erimärkused Sisseehitatud aktiivõefilter Plastikust sahtel mahutite kaanena Plastist raam prügikottide kinnitamiseks Ukse reguleerimine küljelt	2 x 26L	121.0557.764	210,00
	26L + 2x 11L	121.0557.763	210,00

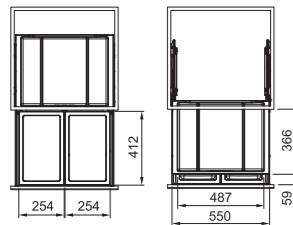
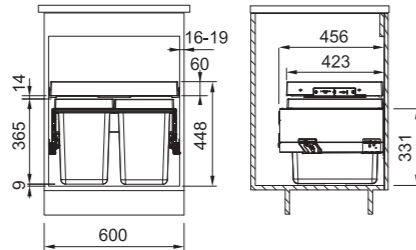
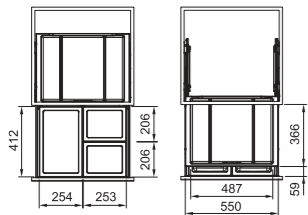

Mudel	Maht	Artikkel	Hind €
EASY SORT 60 Aluskapp 60 cm Mõõdud 564 x 378 x 343 mm Sorteri tüüp Sahtlisse paigaldatav Erimärkused toodetud taaskasutatud plastist eriti tugev käepide (kuni 18 kg) antiseptiline materjal takistab 99% bakterite paljunemist libisemisvastased padjad	3x 14,5L	121.0494.192	39,00
	2x 14,5L + 2x 7,5L	121.0494.193	42,00

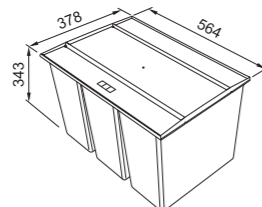

1 3 5 7

Mudel	Maht	Artikkel	Hind €
GARBO 60-4 Aluskapp 60 cm Mõõdud 562 x 399 x 360 mm Sorteri tüüp Esiuksega avatav Paigaldamine Kinnitatakse külgsseite külge Erimärkused Metallist riul mahutite kaanena Ukse reguleerimine küljelt Sujuv sulgumine Täielikult väljatulev, kandejõud 45 kg.	2x 12L + 2x 8L	121.0200.676	149,00

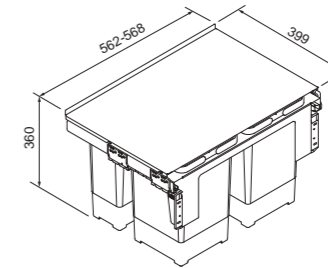

1 2 4 5 6 7 8 9 10 11

Mudel	Maht	Artikkel	Hind €
GARBO 60-3 Aluskapp 60 cm Mõõdud 562 x 399 x 360 mm Sorteri tüüp Esiuksega avatav Paigaldamine Kinnitatakse külgsseite külge Erimärkused Metallist riul mahutite kaanena Ukse reguleerimine küljelt Sujuv sulgumine Täielikult väljatulev, kandejõud 45 kg. Mahuti kasutatud patareidele	18L + 12L + 8L	121.0200.680	149,00

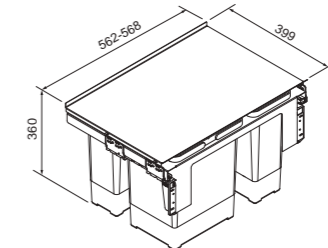

4 9 10

Mudel	Maht	Artikkel	Hind €
GARBO 60-2 Aluskapp 60 cm Mõõdud 562 x 399 x 360 mm Sorteri tüüp Esiuksega avatav Paigaldamine Kinnitatakse külgsseite külge Erimärkused Metallist riul mahutite kaanena Ukse reguleerimine küljelt Sujuv sulgumine Täielikult väljatulev, kandejõud 45 kg.	2x 18L	121.0284.027	149,00

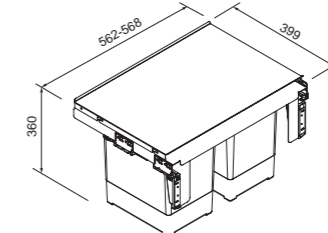

Sorterid aluskapile 50 cm



1 2 3 5 6 7 8

Mudel **GARBO 50-3**
 Aluskapp 50 cm
 Mõõdud 462 x 399 x 360 mm
 Sorteri tüüp Esiuksega avatav
 Paigaldamine Kinnitatakse külgeinte külge
 Erimärkused Metallist riiul mahutite kaanena
 Ukse reguleerimine küljelt
 Sujuv sulgumine
 Täielikult väljatulev, kandejõud 45 kg.

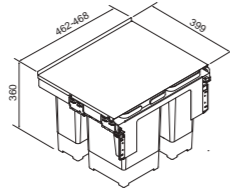

Maht	Artikkel	Hind €
2x 12L + 8L	121.0200.691	143,00



15 16 17 19 20 21 22 23

Mudel **CUBE 50**
 Aluskapp 50 cm
 Mõõdud 470 x 330 x 345 mm
 Sorteri tüüp Küljele avaneva uksega avanev
 Paigaldamine Käsitsi avatav (sorter ukse taga)
 Kapi põhjale kinnitav
 Pööratav
 Erimärkused vajalik 110 ° avanevad uksehinged

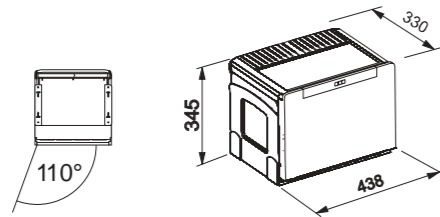

Maht	Artikkel	Hind €
Küljele avaneva uksega avanev		
18L + 14L	134.0055.292	79,00
14L + 2x 8L	134.0055.293	82,00

Sorterid aluskapile 45 cm



2 4 6 8 9 10

Mudel **GARBO 45-2**
 Aluskapp 45 cm
 Mõõdud 412 x 399 x 360 mm
 Sorteri tüüp Esiuksega avatav
 Paigaldamine Kinnitatakse külgeinte külge
 Erimärkused Metallist riiul mahutite kaanena
 Ukse reguleerimine küljelt
 Sujuv sulgumine
 Täielikult väljatulev, kandejõud 45 kg.

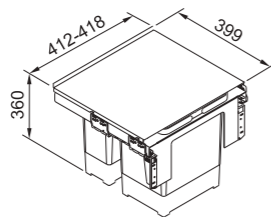

Maht	Artikkel	Hind €
18L + 12L	121.0200.692	138,00



Mudel **EASY SORT 45**
 Aluskapp 45 cm
 Mõõdud 414 x 378 x 343 mm
 Sorteri tüüp Sahtlisse paigaldatav
 Erimärkused toodetud taaskasutatud plastist eriti tugev käepide (kuni 18 kg) antiseptiline materjal takistab 99% bakterite paljunemist libisemisvastased padjad

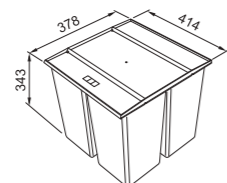

Maht	Artikkel	Hind €
2x 14,5L	121.0494.182	29,00
14,5L + 2x 7,5L	121.0494.150	33,00



Sorterid aluskapile 40 cm



15 18 20 22 23

Mudel **CUBE 40**
 Aluskapp 40 cm
 Mõõdud 335 x 407 x 348 mm
 Sorteri tüüp Küljele avaneva uksega avanev
 Paigaldamine Käsitsi avatav (sorter ukse taga)
 Kapi põhjale kinnitav
 Pööratav
 Erimärkused vajalik 110 ° avanevad uksehinged

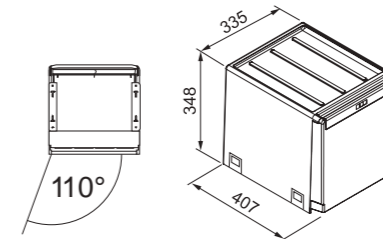

Maht	Artikkel	Hind €
Küljele avaneva uksega avanev		
2x 14L	134.0039.332	72,00
14L + 2x 7L	134.0039.331	75,00



Mudel **SORTER PIVOT**
 Aluskapp 40 cm
 Mõõdud 340 x 340 x 410 mm
 Sorteri tüüp Küljele avaneva uksega avanev
 Paigaldamine Kinnitatakse külgeinte külge
 Pööratav
 Erimärkused Plastist raam prügikottide kinnitamiseks
 Vaja on kasutada kapi ukse sulgur- amor-tisaatorit
 Plastik riiul prügikasti kaanena

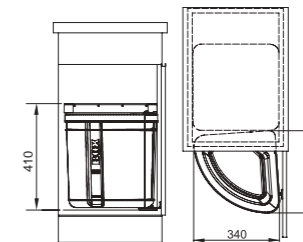

Maht	Artikkel	Hind €
27L	121.0307.563	65,00



Mudel **SORTER MINI**
 Aluskapp 40 cm
 Mõõdud 310 x 310 x 348 mm
 Sorteri tüüp Küljele avaneva uksega avanev
 Paigaldamine Kinnitatakse külgeinte külge
 Pööratav
 Erimärkused Plastist raam prügikottide kinnitamiseks
 Plastik riiul prügikasti kaanena

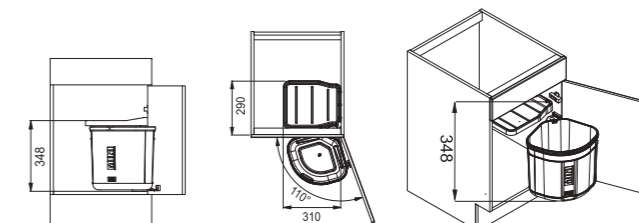

Maht	Artikkel	Hind €
17,5L	121.0176.518	22,00



Sorterid aluskapile 30 cm



12 13 14

Mudel **CUBE 30**
Aluskapp 30 cm
Mõõdud 253 x 467 x 433 mm
Sorteri tüüp Käsitsi avatav (sorter ukse taga)
Paigaldamine Kapi põhjale kinnitav

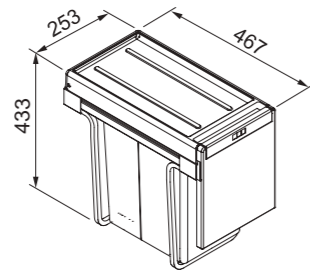

Maht	Artikkel	Hind €
Käsitsi avatav (sorter ukse taga)		
2x 15L	134.0039.553	53,00
20L + 10L	134.0039.554	53,00
3x 10L	134.0039.555	57,00

Nurga sorterid



16 17 19 21 22

Mudel **CUBE CORNER**
Aluskapp Nurgakapi paigaldamine
Mõõdud 345 x 700 x 335 mm
Sorteri tüüp Käsitsi avatav (sorter ukse taga)
Paigaldamine Kapi põhjale kinnitav
Erimärkused Täiendavad prügikastid küljel

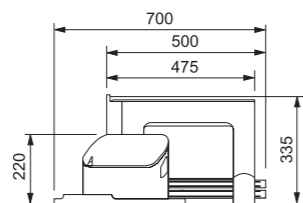

Maht	Artikkel	Hind €
Käsitsi avatav (sorter ukse taga)		
2x 18L	134.0055.286	125,00
18L + 2x 8L	134.0055.288	128,00

Täiendavad lisad sorteerimissüsteemidele

1	133.0251.264	Sangaga plastikust jäätmemahuti 8 L (150 x 225 x 340 mm) € 12,50	2	133.0251.265	Sangaga plastikust jäätmemahuti 12 L (150 x 300 x 340 mm) € 14,00	3	133.0251.269	Sangaga plastikust jäätmemahuti 12 L (225 x 225 x 340 mm) € 14,00	4	133.0251.270	Sangaga plastikust jäätmemahuti 18 L (225 x 300 x 340 mm) € 15,60	5	133.0200.694	Plastikust kaas jäätmemahutile, antratsiit 8 L € 6,10
---	--------------	--	---	--------------	---	---	--------------	---	---	--------------	---	---	--------------	--

6	133.0200.695	Plastikust kaas jäätmemahutile, antratsiit 12 L € 8,10	7	133.0200.698	Aktiivsefiltriga jäätmemahutite plastkaas 8 L € 12,20	8	133.0200.699	Aktiivsefiltriga jäätmemahutite plastkaas 12 L € 16,20	9	133.0284.696	Plastikust kaas jäätmemahutile, antratsiit 18 L € 8,10	10	133.0284.697	Aktiivsefiltriga jäätmemahutite plastkaas 18 L € 16,20
---	--------------	---	---	--------------	--	---	--------------	---	---	--------------	---	----	--------------	---

11	133.0251.271	Plastikust jäätmemahuti 125 x 165 x 75 mm € 4,00	12	133.0042.702	Sangaga plastikust jäätmemahuti 20 L (230 x 295 x 365 mm) € 10,00	13	133.0042.696	Sangaga plastikust jäätmemahuti 15 L (230 x 220 x 365 mm) € 7,90	14	133.0042.678	Sangaga plastikust jäätmemahuti 10 L (230 x 150 x 365 mm) € 6,80	15	133.0023.966	Sangaga plastikust jäätmemahuti 14 L (315 x 185 x 290 mm) € 18,10
----	--------------	--	----	--------------	---	----	--------------	--	----	--------------	--	----	--------------	---

16	133.0016.358	Sangaga plastikust jäätmemahuti 18 L (310 x 220 x 290 mm) € 19,10	17	133.0016.359	Sangaga plastikust jäätmemahuti 8 L (220 x 160 x 290 mm) € 14,10	18	133.0039.556	Sangaga plastikust jäätmemahuti 7 L (150 x 180 x 290 mm) € 5,20	19	133.0014.739	Plastikust kaas jäätmemahutile, antratsiit 18 L € 15,90	20	133.0028.395	Jäätmemahuti plastkaas 14 L € 18,10
----	--------------	---	----	--------------	--	----	--------------	---	----	--------------	--	----	--------------	---

21	133.0014.278	Jäätmemahuti plastkaas 8 L € 12,70	22	133.0016.354	Värvilised kilekottide hoidjad € 1,90	23	134.0039.317	Cube 10 väljatõmmatav sahtel 93 x 407 x 348 mm € 30,00
----	--------------	--	----	--------------	--	----	--------------	--



TURBO ELITE - JÄÄTMEPURUSTAJAD

Lisad

1 112.0489.809

Keraamiliste valamute jaoks mõeldud jäätmepurustaja kinnituse pikendus € 14,00



Jäätmepurustaja paigaldamine



1 UUDIS

Mudel **TE-75**
 Võimsus **550W (0,75 Hp)**
 Pööret minutis **2700**
 Mõõdud **200 x 200 x 371 mm (lisaks väljundtoru)**
 Vajalik pinge **220 V**
 Müratase **40-45 dB**
 Paigaldamine **Kinnitada valamute all oleva 3/2" ventiili asemele**
 Nupu tüüp **Komplekt sisaldab nuppu kraanikausi või tööpinna 35 mm augu jaoks**
 Jäätmepurustaja juhtimine **Jah**
 Antibakteriaalne kaitse **Jah - BioShield korpuse kate**
 Kaal **6,8 kg**

Võimsus	Artikkel	Hind €
0,75Hp	134.0500.618	212,00

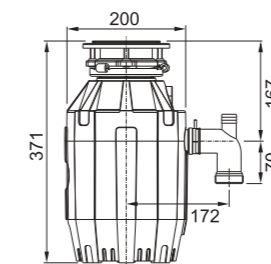

Komplektis on kroomitud nupp. See sobib 35 mm auku. Nupp on jäätmepurustajaga ühendatud toruga, mis suruõhu sisse või välja lülitab. See on täiesti ohutu, kuna pole elektriliselt purustajaga ühendatud.



1 UUDIS

Mudel **TE-50**
 Võimsus **375W (0,5 Hp)**
 Pööret minutis **2600**
 Mõõdud **200 x 200 x 345 mm (lisaks väljundtoru)**
 Vajalik pinge **220 V**
 Müratase **40-45 dB**
 Paigaldamine **Kinnitada valamute all oleva 3/2" ventiili asemele**
 Nupu tüüp **Komplekt sisaldab nuppu kraanikausi või tööpinna 35 mm augu jaoks**
 Jäätmepurustaja juhtimine **Jah**
 Antibakteriaalne kaitse **Jah - BioShield korpuse kate**
 Kaal **5,93 kg**

Võimsus	Artikkel	Hind €
0,5 Hp	134.0500.617	174,00

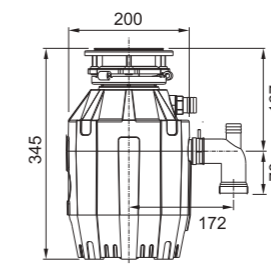

Komplektis on kroomitud nupp. See sobib 35 mm auku. Nupp on jäätmepurustajaga ühendatud toruga, mis suruõhu sisse või välja lülitab. See on täiesti ohutu, kuna pole elektriliselt purustajaga ühendatud.



RULLMATT



Rullmatt on valmistatud roostevabast terasest varrastest, mis on ühendatud silikoonvööga, mis võimaldab seda hõlpsalt kokku keerata. Rullmat on kasulik nii kraanikausi juures oleva võrena kui ka kuumaalusena. Köögikapis hoides saab rullmatti hõlpsalt kokku keerata. Kui see on määrdunud, saab seda nõudepesumasinas pesta. Kuigi silikoonvöö on kuumuskindel, ei saa sellele pikaks ajaks kuumi esemeid panna.

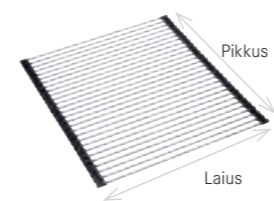

Pilt	Pikkus x Laius	Artikkel	Hind €	Ühildub järgmiste kraanikaussidega	Lk.
	267 x 424 mm	112.0591.081	54,00	Mythos MYX 211, MYX 210-70, MYX 210-50, MYX 210-45 MYX 110-50, MYX 110-45	10. lk. 94. lk.
	400 x 458 mm	112.0281.982	77,40	Argos AGX 211-100, AGX 211-78, AGX 211-62	12. lk.
	468 x 440 mm	112.0080.355	72,10	Box BXX 210/110-68, BXX 210/110-54, BXX 210/110-50, BXX 210/110-45, BXX 210/110-40, BXX 210/110-34 Maris MRX 210-70TL, MRX 210-50TL, MRX 210-40TL	16. lk. 18. lk. 20. lk. 96. lk.
	468 x 420 mm	112.0030.882	69,00	Maris MRX 210-70, MRX 210-50, MRX 210-50, MRX 210-45, MRX 210-40, MRX 210-34, MRX 160-34-19, MRX 110-70, MRX 110-55, MRX 110-50, MRX 110-45, MRX 110-40, MRX 110-34 Mythos (keramiskäs) MTK 611-100, MTK 611-78, MTK 610-58 Kubus KBG 160, KBG 110-50, KBG 110-34 Mythos (keramiskäs) KBK 160, KBK 110-50, KBK 110-40, KBK 110-70	22. lk. 98. lk. 86. lk. 100. lk. 104. lk. 106. lk.
	366 x 326 mm	112.0075.642	47,40	Maris MRG 651, MRG 651-78, MRG 611-100, MRG 611-100XL, MRG 611	52. lk. 54. lk.
	298 x 410 mm	112.0256.867	36,70	Kubus 2 KNG 110-62, KNG 110-50, KNG 110-37	102. lk.





MOBIILNE NÕRUTI

Mobiilne nõruti tagab nõrutuspinna isegi väikese valamuga seal, kus seda vaja on.

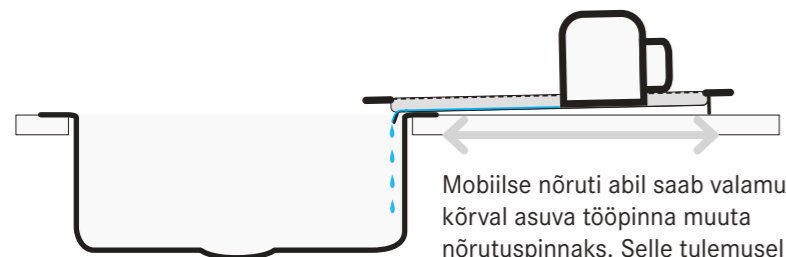

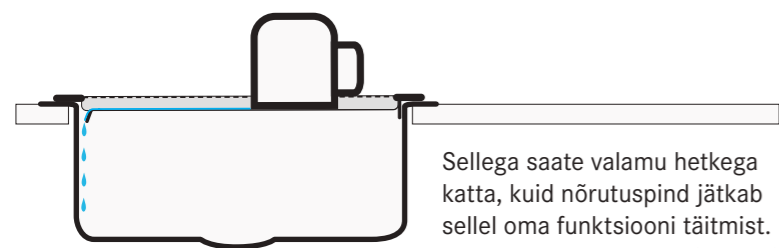

Mobiilse nõruti abil saab valamuga kõrval asuva tööpinna muuta nõrutuspinnaks. Selle tulemusel muutuvad nõrutuspinnata valamud palju funktsionaalsemaks. Sellest tulev vesi satub kraanikaussi selle raami spetsiaalsele avale.

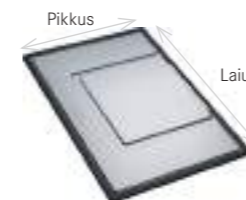

Sellega saate valamuga hetkega katta, kuid nõrutuspind jääb sellel oma funktsiooni täitmist. Määrduvad mobiilset nõrutit võite nõudepesumasinas pesta koos teiste nõudega, ja see on jälle ilma suurema vaevata puhas.



Pilt	Pikkus x Laius	Artikkel	Hind €	Ühildub järgmistega kraanikaussidega	Lk.
	298 x 412 mm	112.0602.288	84,90	Mythos MYX 211, MYX 210-70, MYX 210-50, MYX 210-45 MYX 110-50, MYX 110-45	10. lk. 94. lk.
	326 x 440 mm	112.0204.360	101,90	Box Center BWX 220-54-27 A Box BXX 210/110-68, BXX 210/110-54, BXX 210/110-50, BXX 210/110-45, BXX 210/110-40, BXX 210/110-34 Kubus 2 KNG 110-62, KNG 110-50, KNG 110-37	15. lk. 16. lk. 18. lk. 96. lk. 102. lk.
	342 x 430 mm	112.0188.651	93,70	Maris MRX 210-70TL, MRX 210-50TL, MRX 210-40TL, MRX 210-70, MRX 210-50, MRX 210-50, MRX 210-45, MRX 210-40, MRX 210-34, MRX 160-34-19, MRX 110-70, MRX 110-55, MRX 110-50, MRX 110-45, MRX 110-40, MRX 110-34 Mythos MTK 611-100, MTK 611-78, MTK 610-58 Aton ANX 110-48, ANX 110-34 Kubus KBG 160, KBG 110-50, KBG 110-34 Mythos KBK 160, KBK 110-50, KBK 110-40, KBK 110-70	20. lk. 22. lk. 98. lk. 86. lk. 100. lk. 104. lk. 106. lk.



LÕIKELAUAD

Lõikelaud pole mitte ainult toiduvalmistamiseks mugav, vaid kasulik ka serveerimisel. Saate seda kasutada nii soovitatud valamude juures kui ka oma äranägemise järgi.



Pilt	Pikkus x Laius	Artikkel	Hind €	Ühildub järgmiste kraanikaussidega	Lk.
Lõikelaud Stonepaper Slate					
	180 x 412 mm	112.0591.082	94,60	Mythos MYX 211, MYX 210-70, MYX 210-50, MYX 210-45 MYX 110-50, MYX 110-45	10. lk. 94. lk.
Lõikelaud-plastik					
	429 x 180 mm	112.0539.120	47,80	Box BXX 210/110-68, BXX 210/110-54, BXX 210/110-50, BXX 210/110-45, BXX 210/110-40, BXX 210/110-34	16. lk. 18. lk. 96. lk.
	200 x 510 mm	112.0520.471	38,60	Maris MRX 210-70TL, MRX 210-50TL	20. lk.
	200 x 440 mm	112.0530.071	38,60	Maris MRX 210-34TL, MRX 210-50TL, MRX 210-70, MRX 210-50, MRX 210-50, MRX 210-45, MRX 210-40, MRX 210-34, MRX 160-34-19, MRX 110-70, MRX 110-55, MRX 110-50, MRX 110-45, MRX 110-40, MRX 110-34	20. lk. 22. lk. 98. lk. 100. lk.
	210 x 476 mm	112.0271.449	49,00	Spark SKX 651, SKX 611-86, SKX 611-79, SKX 611-62, SKN 611-62	24. lk.
Puidust lõikelaud					
	280 x 532 mm	112.0595.334	39,60	FX FXG 611-100, FXG 611-78 Maris MRG 651, MRG 651-78, MRG 611-100, MRG 611-100XL Urban UBG 651-100, UBG 611-100, UBG 611-86, UBG 611-78, UBG 611-78XL, UBG 611-62, UBG 610-56 Centro CNG 611-86, CNG 611-78, CNG 611-62, CNG 61-54, CNG 610-39 Sirius S2D 651, S2D 611-100, S2D 611-78, S2D 611-78XL, S2D 611-62	50. lk. 52. lk. 54. lk. 62. lk. 64. lk. 66. lk. 68. lk. 78. lk. 80. lk.
	362 x 447 mm	112.0035.622	60,70	Argos AGX 211-100, AGX 211-78, AGX 211-62	12. lk.
	340 x 400 mm	112.0040.682	46,00	Rapid RPX 611-86XL, RPX 211 Smart SRX 611, SRX 611-86 Logica Line LLX 611	27. lk. 28. lk. 34. lk.
	300 x 400 mm	112.0338.711	59,40	Mythos MTK 611-100, MTK 611-78	86. lk.
Lõikelaud- klaas					
	280 x 408 mm	112.0017.900	39,20	Mythos MTG 651-100, MTG 611 Maris MRG 610-58, MRG 610-42, MRG 620	48. lk. 56. lk.



NÕRUTUSKAUSID

Nõrutuskauss on köögivalamu tähtis abiline. Näiteks köögiviljade loputamisel, et lasta neil kuivada. Nõrutuskaussi saab pesta nõudepesumasinas ja selle kasutamine on väga hügieeniline. Kui nõrutuskaussi ei ole valamu põhikomplektis, siis soovime teil see lisaks osta, et köögivalamuga tööd veelgi hõlbustada.



Pilt	Pikkus x Laius	Artikkel	Hind €	Ühildub järgmiste kraanikaussidega	Lk.
Nõrutuskauss, rv teras plastik raam					
	180 x 412 mm	112.0599.107	98,40	Mythos MYX 211, MYX 210-70, MYX 210-50, MYX 210-45 MYX 110-50, MYX 110-45	10. lk. 94. lk.
	181 x 431 mm	112.0520.497	48,30	Maris MRX 210-70TL, MRX 210-50TL	20. lk.
	156 x 417 mm	112.0066.060	91,50	Maris MRG 611-100, MRG 611-100XL, MRG 611-78XL, MRG 611, MRG 611-62, MRG 612-E Urban UBG 651-100, UBG 611-100, UBG 611-86, UBG 611-78, UBG 611-78XL, UBG 611-62, UBG 610-56 Kubus 2 KNG 110-62, KNG 110-52, KNG 110-37	52. lk. 54. lk. 56. lk. 62. lk. 64. lk. 102. lk.
	429 x 156 mm	112.0394.981	91,50	Box BXX 210/110-68, BXX 210/110-54, BXX 210/110-50, BXX 210/110-45, BXX 210/110-40, BXX 210/110-34	16. lk. 18. lk. 96. lk.
Nõrutuskauss- roostevaba teras					
	412 x 172 mm	112.0057.850	38,60	Maris MRX 210-40TL, MRX 210-70, MRX 210-50, MRX 210-50, MRX 210-45, MRX 210-40, MRX 210-34, MRX 160-34-19, MRX 110-70, MRX 110-55, MRX 110-50, MRX 110-45, MRX 110-40, MRX 110-34	20. lk. 22. lk. 98. lk. 100. lk.
	412 x 172 mm	112.0017.788	53,80	Maris MRX 210-70TL, MRX 210-50TL Kubus KBG 160, KBG 110-50, KBG 110-34	20. lk. 105. lk.
	200 x 440 mm	112.0018.817	39,20	Mythos MTG 651-100, MTG 611 Maris MRG 610-58, MRG 610-42	48. lk. 56. lk.
	150 x 325 mm	112.0057.214	48,80	Maris MRG 651, MRG 651-78	52. lk.
	160 x 300 mm	112.0250.014	40,90	Basis BFG 651, BFG 651-78	58. lk.
	187 x 297 mm	112.0461.942	39,20	Spark SKX 651	24. lk.
	200 x 264 mm	112.0006.138	28,60	Spark SKX 651-E	26. lk.
Plastikust nõrutuskauss hall					
	456 x 179 mm	112.0512.280	19,20	FX FXG 611-100, FXG 611-78 Sirius S2D 651, S2D 611-100, S2D 611-78, S2D 611-78XL, S2D 611-62	50. lk. 78. lk. 80. lk.
	181 x 440 mm	112.0538.950	17,30	Urban UBG 651-100, UBG 611-100, UBG 611-86, UBG 611-78, UBG 611-78XL, UBG 611-62, UBG 610-56	62. lk. 64. lk.
	174 x 320 mm	112.0566.182	13,10	Urban UBG 651-100	62. lk.

Äravoolu komplektid vajutusnupuga



Mudel	Ventii	Väikese kausi ventii	Ülevool 1	Ülevool 2	Vajutusnupp	Ühendustorud 1	Ühendustorud 2	Äravoolumate
Roostevabast terasest valamud								
ARGOS G								
AGX 211-100	112.0301.673		133.0036.506		133.0391.835	112.0059.946		
AGX 211-78	112.0301.673		133.0036.506		133.0391.835	112.0006.411		
AGX 211-62	112.0301.673		133.0036.506		133.0391.835	112.0006.411		
BOX CENTRE								
BWX 220-54-27A	112.0173.076	112.0049.409	133.0254.554	113.0050.083	133.0391.835	112.0048.209		112.0532.169
BOX								
BXX 210/110-68	112.0301.673		133.0254.554		133.0391.835	112.0006.411		
BXX 210/110-54	112.0301.673		133.0254.554		133.0391.835	112.0006.411		
BXX 210/110-50	112.0301.673		133.0254.554		133.0391.835	112.0006.411		
BXX 210/110-45	112.0301.673		133.0254.554		133.0391.835	112.0006.411		
BXX 210/110-40	112.0301.673		133.0254.554		133.0391.835	112.0006.411		
BXX 210/110-34	112.0301.673		133.0254.554		133.0391.835	112.0006.411		
MYTHOS								
MYX 211 A	112.0301.673		133.0036.506		133.0391.835	112.0059.946		112.0190.628
MYX 210-70	112.0301.673		133.0498.637		112.0611.460			112.0532.169
MYX 210-50 (110-50)	112.0301.673		133.0498.637		112.0611.460			112.0532.169
MYX 210-45 (110-45)	112.0301.673		133.0498.637		112.0611.460			112.0532.169
Fragranit valamud								
FRESNO								
FXG 611-88	112.0389.090		133.0050.083		133.0391.835	112.0554.767	133.0336.625	112.0395.171
FX								
FXG 611-100	112.0389.090		133.0173.094		133.0391.835	112.0006.411		112.0480.588
FXG 611-78	112.0389.090		133.0173.094		133.0391.835	112.0006.411		112.0480.588
KUBUS								
KBG 160	112.0389.090	112.0049.409	133.0050.134		133.0391.835	112.0006.411	133.0006.408	
KBG 110-50	112.0389.090		133.0173.094		133.0391.835	112.0006.411		
KBG 110-34	112.0389.090		133.0173.094		133.0391.835	112.0006.411		
KUBUS 2								
KNG 110-62	112.0389.090		133.0537.983		133.0391.835	112.0006.411		112.0395.171
KNG 110-52	112.0389.090		133.0537.983		133.0391.835	112.0006.411		112.0395.171
KNG 110-37	112.0389.090		133.0537.983		133.0391.835	112.0006.411		112.0395.171
MYTHOS								
MTG 651-100	112.0389.090	112.0307.599	133.0459.872		133.0391.835	112.0006.411	133.0006.408	
MTG 611-100	112.0389.090		133.0459.872		133.0391.835	112.0006.411		
Keraamiline valamud								
KUBUS								
KBK 160	112.0331.971	133.0395.083			133.0391.835	112.0006.411	133.0006.408	
KBK 110-50	112.0331.953		133.0459.871		133.0391.835	112.0006.411	133.0336.625	
KBK 110-40	112.0331.953		133.0459.871		133.0391.835	112.0006.411	133.0336.625	
KBK 110-70	112.0331.953		133.0459.871		133.0391.835	112.0006.411	133.0336.625	
MYTHOS								
MTK 611-100	112.0331.953		133.0459.871		133.0391.835	112.0006.411	133.0336.625	
MTK 611-78	112.0331.953		133.0459.871		133.0391.835	112.0006.411		
MTK 610-58	112.0331.953		133.0459.871		133.0391.835	112.0006.411	133.0336.625 x2	

Valamute tarvikud

1 112.0301.673
3½" ekstsenterventiil (nupuga avatav)
€ 38,60



2 112.0389.090
3½" ekstsenterventiil (nupuga avatav)
€ 38,60



3 112.0331.953
3½" ekstsenterventiil (nupuga avatav)
€ 29,00



4 112.0331.971
3½" ekstsenterventiil (nupuga avatav)
€ 29,00



5 112.0307.599
Ventii 3½" käsijuhtimisega
€ 14,50



6 112.0049.409
Ventii 3½" käsijuhtimisega
€ 15,80



7 112.0307.597
Ventii 3½" käsijuhtimisega
€ 11,60



8 133.0395.082
Ventii 1½" käsitsi juhtimisega väikese kausi jaoks
€ 29,30



9 133.0395.083
Ventii 1½" käsitsi juhtimisega väikese kausi jaoks
€ 28,60



10 133.0391.835
Ümar vajutusnupp roostevabast terasest
€ 57,10



11 133.0173.094
Kaetud ülevool katteplaadi ja teleskoopse ühendusega
€ 27,60



12 133.0254.554
Kaetud ülevool katteplaadi ja teleskoopse ühendusega
€ 10,50



13 133.0254.556
Kaetud ülevool katteplaadi ja teleskoopse ühendusega
€ 8,90



14 133.0036.506
Kaetud ülevool katteplaadi ja teleskoopse ühendusega
€ 27,60



15 133.0459.871
Kaetud ülevool katteplaadi ja teleskoopse ühendusega
€ 19,50



16 133.0459.872
Kaetud ülevool katteplaadi ja teleskoopse ühendusega
€ 19,50



17 133.0336.625
Ühendustoru 105 mm
€ 1,90



18 112.0006.411
Ühendus sifooni 1½" jaoks
€ 2,80



19 133.0006.408
Ühendus suure ja väikese kausi jaoks 1½"
€ 4,10

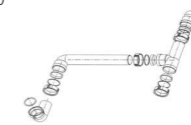

20 133.0006.405
Ühendus suure ja väikese kausi jaoks 1½"
€ 7,30



21 112.0480.588
Ümar ventiili kate roostevabast terasest
€ 12,50



22 112.0395.171
Nelinarurkne ventiili kate roostevabast terasest 125 x 125 mm
€ 5,90



Ventiilide komplektid valamutele

Valamu mudel	Ventiili tüüp	Ventiil ArtNr	Hind €
Roostevaba teras			
ATON			
ANX 110-48	Nupuga	112.0339.590	68,00
ANX 110-34	Nupuga	112.0339.590	68,00
BELL			
BCX 610-51	Käsitsi	112.0626.585	20,00
BOX			
BXX 210/110-68	Käsitsi	112.0375.401	27,00
BXX 210/110-54	Käsitsi	112.0375.401	27,00
BXX 210/110-50	Käsitsi	112.0375.401	27,00
BXX 210/110-45	Käsitsi	112.0375.401	27,00
BXX 210/110-40	Käsitsi	112.0375.401	27,00
BXX 210/110-34	Käsitsi	112.0375.401	27,00
LOGICA LINE			
LLX 611	Nupuga	112.0059.982	7,00
MARIS			
MRX 210-70 TL	Käsitsi	112.0049.409	16,00
		133.0036.506	28,00
MRX 210-50 TL	Käsitsi	112.0049.409	16,00
		133.0036.506	28,00
MRX 210-40 TL	Käsitsi	112.0049.409	16,00
		133.0036.506	28,00
MRX 260-34-19 / 160-34-19	Käsitsi	112.0049.409	16,00
		133.0036.506	28,00
MRX 220-40-40 / 120-40-40	Käsitsi	112.0049.409	16,00
		133.0036.506	28,00
MRX 210-70 / 110-70	Käsitsi	112.0049.409	16,00
		133.0036.506	28,00
MRX 210-55 / 110-55	Käsitsi	112.0049.409	16,00
		133.0036.506	28,00
MRX 210-50 / 110-50	Käsitsi	112.0049.409	16,00
		133.0036.506	28,00
MRX 210-45 / 110-45	Käsitsi	112.0049.409	16,00
		133.0036.506	28,00
MRX 210-40 / 110-40	Käsitsi	112.0049.409	16,00
		133.0036.506	28,00
MRX 210-34 / 110-34	Käsitsi	112.0049.409	16,00
		133.0036.506	28,00
MRX 210-19 / 110-19	Käsitsi	112.0049.409	16,00
		133.0036.506	28,00
MIKADO			
MOX 260	Nupuga	112.0006.263	34,00
QUADRANT			
QAX 210	Nupuga	112.0006.249	38,00
RAPID			
RPX 611-86XL	Nupuga	112.0382.399	35,00
RPX 211	Nupuga	112.0382.399	35,00
SPARK			
SKX 651	Nupuga	112.0006.263	34,00
SKX 611-100	Nupuga	112.0006.209	24,00
SKX 611	Nupuga	112.0006.209	24,00
SKX 620-86	Nupuga	112.0006.218	40,00
SKX 621	Nupuga	112.0006.218	40,00
SKX 651-E	Nupuga	112.0013.866	46,00
SMART			
SRX 611-86XL	Käsitsi	112.0049.409	16,00
SRX 611-86	Käsitsi	112.0049.409	16,00

Fragranit			
BASIS			
BFG 651	Nupuga	112.0059.713	41,00
BFG 651-78	Nupuga	112.0059.713	41,00
BFG 611 / 611-86	Nupuga	112.0059.714	31,00
BFG 611-62	Nupuga	112.0059.714	31,00
CENTRO			
CNG 611-86	Nupuga	112.0625.583	48,00
CNG 611-78	Nupuga	112.0625.583	48,00
CNG 611-62	Nupuga	112.0625.583	48,00
CNG 610-54	Nupuga	112.0625.583	48,00
CNG 610-39	Nupuga	112.0625.583	48,00
KUBUS			
KBG 160	Käsitsi	112.0478.951	70,00
KBG 110-50	Käsitsi	112.0478.929	46,00
KBG 110-34	Käsitsi	112.0478.929	46,00
MARIS			
MRG 610-42	Nupuga	112.0006.374	40,00
MRG 610-58	Nupuga	112.0079.766	26,00
MRG 611	Nupuga	112.0059.714	31,00
MRG 611-62	Nupuga	112.0059.714	31,00
MRG 611-100	Nupuga	112.0059.714	31,00
MRG 611-78 XL	Nupuga	112.0059.714	31,00
MRG 612-E	Nupuga	112.0059.714	31,00
MRG 620	Nupuga	112.0079.766	26,00
MRG 651	Nupuga	112.0059.713	41,00
MRG 651-78	Nupuga	112.0059.713	41,00
RONDA			
ROG 610-41	Nupuga	112.0006.374	40,00
ROG 610-41	Käsitsi	112.0006.346	21,00
ROG 611-62	Käsitsi	112.0006.346	21,00
ROG 611	Nupuga	112.0006.374	40,00
ROG 611	Käsitsi	112.0006.346	21,00
STRATA			
STG 614	Käsitsi	112.0006.283	21,00
		112.0016.302	6,00
STG 614-78	Käsitsi	112.0006.283	21,00
		112.0016.302	6,00
URBAN			
UBG 651-100	Nupuga	112.0597.969	57,00
		112.0538.950	18,00
UBG 611-100	Nupuga	112.0597.952	47,00
UBG 611-86	Nupuga	112.0597.952	47,00
UBG 611-78	Nupuga	112.0597.952	47,00
UBG 611-78XL	Nupuga	112.0597.952	47,00
UBG 611-62	Nupuga	112.0597.952	47,00
UBG 610-56	Nupuga	112.0598.003	50,00
TECTONITE			
SINGLE			
SINGLE 1	Käsitsi	112.0008.383	21,00
SIRIUS			
S2D 651	Käsitsi	112.0264.381	36,00
S2D 611-100	Käsitsi	112.0264.380	19,00
S2D 611-78	Käsitsi	112.0264.380	19,00
S2D 611-78XL	Käsitsi	112.0264.380	19,00
S2D 611-62	Käsitsi	112.0264.380	19,00
SID 610-40	Käsitsi	112.0006.346	21,00
SID 610	Käsitsi	112.0006.346	21,00
Keraamiline			
SGK 611-86	Nupuga	112.0595.365	40,00
SGK 610-86	Nupuga	112.0575.921	43,00

Valamute tarvikud

1 133.0005.681
Põhjasõel 3½" - käsitsi avatav
€ 11,00



2 133.0008.411
Põhjasõel 3½" - käsitsi avatav
€ 11,00



3 133.0049.669
Põhjasõel integreeritud ventiilile 3½" - käsitsi avatav
€ 9,00



4 133.0008.412
Põhjasõel 3½" - nupuga avatav
€ 12,00



5 133.0005.611
Põhjasõel 3½" - nupuga avatav
€ 12,00



6 133.0049.668
Põhjasõel integreeritud ventiilile 3½" - nupuga avatav
€ 10,00



7 112.0473.656
Augufrees 35mm Fragranit ja Tectonite valamutele
€ 3,90



8 112.0008.476
Augu 35mm jaoks
€ 36,90



9 112.0006.333
Roostevabast terasest valamu käsifrees 35 mm augu jaoks
€ 1,80



10 112.0085.384
Roostevabast terasest valamu kinnituskomplekt kleebise ja tihendiga
€ 3,20



11 992.0019.488
Fragranite valamute kinnituskomplekt (6 tk)
€ 2,90



12 133.0026.896
Segisti kinnitus roostevabast terasest valamute jaoks. Takistab segisti liikumist. Reguleeritav.
€ 10,20



13 133.0297.561
Mudafilter, lihtne hooldada, ¾" ühendusega (2 tk)
€ 29,50



14 133.0272.273
Silindriline kõõgisekisti kinnitusvõti 38 mm. Pikkus 196 mm
€ 5,80



UUDIS

15 112.0006.411
Ühendus sifooni 1½" jaoks
€ 2,80



16 112.0006.412
Universaalne ruumisäästlik sifoon 1½" * 1 m
€ 4,40



17 112.0006.456
Painduva ühendusega sifoon 1½"
€ 9,70



18 112.0006.330
Ventiili komplekt 3½" käsijuh-timisega
€ 5,10



19 133.0172.724
Pudel Novita seebidosaatorile 300 ml
€ 10,30





RUUMI SÄÄSTVA SIFOONI PAIGALDAMINE
112.0006.412
Universaalne ruumisäästlik sifoon 1½" * 1 m
€ 4,40



Valik segistite varuosi



Segisti mudel	Tööosa	Hind €	Tihendikomplekt	Hind €	Aeraator	Hind €	Dušivoolik	Hind €
Active Neo (Fikseeritud tila)	133.0173.623	34,10	133.0274.957	8,50	133.0357.091	10,80		
Active Neo (Väljatõmmatav)	133.0173.623	34,10	133.0274.957	8,50			133.0062.362	39,20
Active Window	133.0004.819	26,40			133.0277.209	22,30	133.0005.266	33,30
Active-Plus	133.0173.623	34,10	133.0274.957	8,50	133.0358.376	7,70	133.0378.425	53,50
Ambient (Fikseeritud tila)	133.0434.739	21,20	133.0434.740	3,20	133.0434.734	6,10		
Ambient (Väljatõmmatav)	133.0434.739	21,20	133.0434.751	6,00	133.0434.688	6,00	133.0434.690	27,30
Argos	133.0197.942	21,20			133.0304.226	77,80		
Atlas (Fikseeritud / ekstraheeritav)	133.0372.710	16,10	133.0154.797	2,60	133.0056.087	7,30	133.0442.981	17,60
Atlas Neo (Väljatõmmatav)	133.0464.738	9,70	133.0560.579	1,50	133.0567.687	4,90	133.0560.580	17,40
Atlas Neo (Fikseeritud tila)	133.0464.738	9,70	133.0560.571	1,40	133.0567.687	4,90		
Atlas Window	133.0372.710	16,10	133.0154.797	2,60	133.0544.458	5,70	133.0383.837	13,70
BAT 650 kroom	133.0257.342	11,10	133.0257.340	0,20	133.0257.339	3,40		
BAT 740	133.0008.210	16,60			133.0005.933	2,50	133.0008.215	17,90
BAT 750	133.0008.210	16,60	133.0004.834	2,60	133.0005.933	2,50		
Centinox	133.0185.125	26,40			133.0185.126	9,30	133.0185.154	73,00
Elegance	133.0197.942	21,20			133.0374.217	10,80		
Eos Neo (Väljatõmmatav)	133.0464.738	9,70			133.0574.812	16,30	133.0599.703	
Eos Neo (Fikseeritud tila)	133.0464.738	9,70	133.0599.667		133.0599.670			
Flexus-S Jet	133.0285.469	17,90			133.0327.249	10,80	133.0283.811	23,00
Fluence (Fikseeritud tila)	133.0359.291	20,70	133.0359.293	0,60	133.0395.645	5,10		
Fluence (Väljatõmmatav)	133.0359.291	20,70	133.0359.293	0,60	133.0285.462	6,00	133.0395.646	33,30
Format	133.0197.942	21,20			133.0372.795	10,80		
Gaia (Fikseeritud / ekstraheeritav)	133.0372.710	16,10			133.0264.958	6,80	133.0064.301	33,30
Grammy (Fikseeritud / ekstraheeritav)	133.0274.802	29,00	133.0278.364	3,40	133.0275.555	10,80	133.0278.365	50,30
Ira (Fikseeritud / ekstraheeritav)	133.0355.676	10,60	133.0344.340	4,10	133.0344.338	4,10	133.0344.339	18,30
Kubus	133.0464.738	9,70	133.0560.586	1,50	133.0560.590	96,50	133.0560.592	12,20
Leda (Fikseeritud tila)	133.0372.710	16,10			133.0056.086	10,80		
Leda (Väljatõmmatav)	133.0372.710	16,10			133.0154.638	24,60	133.0064.301	33,30
Lounge (Väljatõmmatav)	133.0197.942	21,20			133.0374.217	10,80	133.0197.946	100,80
Lounge (Fikseeritud tila)	133.0197.942	21,20	133.0273.891	10,60	133.0357.291	7,70		
Maris (Väljatõmmatav)	133.0503.598	27,70	133.0434.751	6,00	133.0503.599	45,40	133.0434.690	27,30
Maris (Fikseeritud tila)	133.0503.598	27,70	133.0503.594	8,10	133.0503.591	14,30		
Maris J-spout	133.0503.598	27,70			133.0541.313			
Meos (Fikseeritud / ekstraheeritav)	133.0051.039	25,60			133.0507.437	10,10	133.0158.021	33,30
Mondial 4 in 1	133.0488.925	31,50			133.0488.954	60,80		
Mythos (Väljatõmmatav)	133.0567.700	8,70	133.0569.550	1,80	133.0567.698	3,90	133.0474.795	4,10
Mythos (Fikseeritud tila)	133.0567.700	8,70	133.0569.550	1,80	133.0567.698	3,90		
Neptune-Evo (Fikseeritud tila)	133.0434.739	21,20	133.0434.740	3,20	133.0434.687	6,30		
Neptune-Evo (Väljatõmmatav)	133.0434.739	21,20	133.0434.751	6,00	133.0434.736	6,30	133.0434.690	27,30
Novara Eco	133.0339.424	50,30	133.0294.225	7,70	133.0357.091	10,80		
Novara Plus (Väljatõmmatav)	133.0382.190	9,70	133.0457.253	0,40	133.0518.506	1,70	133.0518.508	14,80
Novara Plus (Fikseeritud tila)	133.0382.190	9,70	133.0457.251	0,30	133.0382.201	2,60		
Old England	133.0054.664	37,20						
Orbit (Fikseeritud tila)	133.0574.743	9,80			133.0574.744	5,40		
Orbit (Väljatõmmatav)	133.0574.743	9,80			133.0574.750	5,10	133.0574.749	11,40
Pescara 360	133.0197.942	21,20			133.0357.291	7,70		
Pescara L	133.0386.387	9,50	133.0510.510	3,00	133.0510.536	4,10	133.0510.538	72,20
Pescara slide in	133.0541.164	12,00			133.0541.176	0,70	133.0541.168	15,10
Pescara up&down	133.0197.942	21,20						
Pescara XL	133.0464.738	9,70	133.0510.510	3,00	133.0510.507	4,00	133.0510.509	85,40
Pio	133.0276.913	17,90	133.0276.914	1,90	133.0328.082	1,70		
Planario Tower	133.0065.972	54,30			133.0263.564	16,60		
Platino	133.0594.462	23,40			133.0005.935	10,70	133.0051.071	33,30
Platino	133.0054.678	21,20			133.0060.376	9,30	133.0051.071	33,30
Rotondo	133.0276.913	17,90			133.0343.946	0,80	133.0051.071	33,30
Samoa	133.0005.737	21,80			133.0255.835	4,60		
Sinos	133.0065.972	54,30			133.0283.815	12,40	133.0283.835	45,40
Sinta	133.0323.563	25,60			133.0327.554	2,60	133.0326.129	39,30
Sirius	133.0513.672	34,00			133.0571.175	13,70		
Smart	133.0470.703	10,50			133.0470.690	4,10	133.0471.051	19,20
Taros	133.0372.710	16,10			133.0056.087	10,80	133.0383.837	13,70
Taros Window	133.0372.710	16,10			133.0056.087	10,80	133.0383.837	13,70
Tico	133.0197.942	21,20	133.0357.289	6,80	133.0357.291	7,70		
Vital Schwenk	133.0574.430	17,00			133.0587.553	6,90		
Vital Semi-Pro	133.0574.430	17,00					133.0587.545	157,70
Wellfresh 110	133.0372.710	16,10			133.0253.228	15,30		
Wellfresh 110	133.0372.710	16,10			133.0253.228	15,30		
Wellfresh 150	133.0253.214	23,00	133.0253.211	2,60				

Valamu ja segisti puhastusvahendid

112.0007.715
Franke Twister käsna
125 ml
€ 5,50



112.0007.459
Franke Twister käsna
komplektis karbis
12x 125ml
€ 64,50



112.0007.712
Franke Maratoni lubjastane,
komplekt 3 pudeliga
€ 35,50



112.0579.123
HOOLDUSVAHEND Värvilised
valamud
250 ml
€ 11,00



112.0579.124
HOOLDUSVAHEND Segistite
jaoks
250 ml
€ 11,00



112.0530.240
HOOLDUSVAHEND Õhupuhas-
tite jaoks
250 ml
€ 11,00



112.0304.193
Puhastuskäsna komplekt
€ 3,20



112.0530.324
HOOLDUSVAHEND mikrokiust
lapp
€ 8,00



Franke art.nr. registrid

Art.Nr.	Lk.	Art.Nr.	Lk.	Art.Nr.	Lk.
101					
101.0000.561	31	112.0057.850	20, 22, 98, 100, 169	112.0595.334	50, 52, 54, 58, 60, 62, 64, 66, 68, 78, 80, 167
101.0009.362	37	112.0059.713	172	112.0595.365	172
101.0009.363	37	112.0059.714	172	112.0597.952	172
101.0009.496	30	112.0059.982	25, 172	112.0597.969	172
101.0009.497	30	112.0066.060	52, 54, 56, 62, 64, 102, 169	112.0598.003	172
101.0009.909	37	112.0075.642	52, 54, 163	112.0599.107	10, 94, 169
101.0016.461	33	112.0079.766	172	112.0602.288	10, 94, 165
101.0017.705	33	112.0080.355	16, 18, 20, 96, 163	112.0607.497	115
101.0017.901	31	112.0085.384	173	112.0607.498	115
101.0017.915	31	112.0188.651	20, 22, 98, 100, 104, 106, 165	112.0625.583	172
101.0017.919	31	112.0204.360	15, 16, 18, 56, 96, 102, 165	112.0626.585	172
101.0017.998	31	112.0250.014	58, 169	114	
101.0035.362	33	112.0256.867	102, 163	114.0009.505	71
101.0035.407	32	112.0264.380	172	114.0009.506	71
101.0085.772	34	112.0264.381	172	114.0009.509	71
101.0085.773	34	112.0271.449	24, 167	114.0009.513	71
101.0288.025	35	112.0281.982	12, 163	114.0009.542	71
101.0288.027	36	112.0301.673	171	114.0009.543	71
101.0288.041	36	112.0304.193	175	114.0009.546	71
101.0356.758	28	112.0307.597	171	114.0009.550	71
101.0356.759	28	112.0307.599	171	114.0029.525	70
101.0356.850	28	112.0331.953	171	114.0029.528	70
101.0464.044	24	112.0331.971	171	114.0302.708	55
101.0464.337	25	112.0338.711	86, 167	114.0302.711	57
101.0464.340	26	112.0339.590	172	114.0302.751	72
101.0498.889	27	112.0375.401	172	114.0302.757	72
101.0554.877	25	112.0382.399	172	114.0302.760	72
101.0554.878	25	112.0389.090	171	114.0303.666	73
101.0605.605	25	112.0394.981	16, 18, 96, 169	114.0303.669	73
101.0622.893	29	112.0394.981	16, 18, 96, 169	114.0303.670	73
103		112.0395.171	171	114.0303.671	73
103.0013.774	35	112.0461.942	24, 169	114.0303.672	73
112		112.0473.656	50, 52, 55, 56, 58, 60, 62, 64, 66, 68, 71, 73, 102, 173, 178	114.0316.526	71
112.0006.138	26, 169	112.0478.929	172	114.0316.528	71
112.0006.209	172	112.0478.951	172	114.0336.417	59
112.0006.218	33, 172	112.0480.588	171	114.0336.914	59
112.0006.230	37	112.0485.906	25	114.0336.916	59
112.0006.249	172	112.0489.809	161	114.0336.938	59
112.0006.263	172	112.0512.280	50, 78, 80, 169	114.0336.939	59
112.0006.274	32	112.0520.471	20, 167	114.0368.449	80
112.0006.283	172	112.0520.497	20, 169	114.0368.466	80
112.0006.318	35	112.0530.071	20, 22, 98, 100, 167	114.0368.467	80
112.0006.330	173	112.0530.071	20, 22, 98, 100, 167	114.0378.095	53
112.0006.331	33	112.0530.240	175	114.0378.121	53
112.0006.332	33, 36	112.0530.324	175	114.0378.124	53
112.0006.333	173	112.0538.950	62, 64, 169, 172	114.0378.125	53
112.0006.341	30	112.0539.120	16, 18, 96, 167	114.0378.126	53
112.0006.346	172	112.0544.226	15	114.0463.691	81
112.0006.351	31	112.0566.182	62, 169	114.0463.692	81
112.0006.374	172	112.0575.921	172	114.0463.694	81
112.0006.411	171, 173	112.0579.123	175	114.0463.698	81
112.0006.412	37, 173	112.0591.081	10, 94, 163	114.0463.958	80
112.0006.456	173	112.0607.712	175	114.0476.963	48
112.0007.459	175	112.0625.625	58	114.0476.964	48
112.0007.712	175	112.0625.626	67	114.0476.965	48
112.0007.715	175	112.0625.629	67	114.0476.966	48
112.0008.383	172	112.0625.630	67	114.0476.967	48
112.0008.398	35	112.0625.631	67	114.0476.968	48
112.0008.476	173	112.0625.632	66	114.0476.969	48
112.0013.866	172	112.0625.641	66	114.0476.970	48
112.0016.302	172	112.0625.643	66	114.0476.987	48
112.0017.788	104, 169	112.0625.644	66	114.0476.988	48
112.0017.900	48, 56, 167	112.0625.645	66	114.0476.995	49
112.0018.817	48, 56, 169	112.0627.652	69	114.0476.996	49
112.0030.882	22, 86, 98, 100, 104, 106, 163	112.0627.654	68	114.0476.997	49
		112.0627.656	69	114.0476.998	49
		112.0627.659	69	114.0476.999	49
		112.0627.660	68	114.0477.000	49
		112.0627.676	69	114.0477.021	49
		112.0627.677	68	114.0477.022	49
		115		114.0477.041	49
		115.0028.205	148	114.0477.044	49
		115.0028.208	148	114.0479.022	54
		115.0046.072	147	114.0479.027	54
		115.0060.360	148	114.0479.030	54
		115.0156.315	147	114.0479.031	54
		115.0180.686	148	114.0301.331	61
		115.0347.111	143	114.0301.332	61

Art.Nr.	Lk.	Art.Nr.	Lk.	Art.Nr.	Lk.
114.0301.333	61	114.0499.970	81	115.0347.142	143
114.0301.335	61	114.0500.012	81	115.0364.903	147
114.0301.342	61	114.0500.018	81	115.0373.770	137
114.0301.345	59	114.0500.019	81	115.0373.790	137
114.0301.361	59	114.0512.337	50	115.0373.811	137
114.0301.367	59	114.0512.339	50	115.0373.817	137
114.0301.368	59	114.0512.340	50	115.0373.818	137
114.0301.370	59	114.0512.361	50	115.0373.820	137
114.0301.373	61	114.0512.362	50	115.0373.821	137
114.0301.903	61	114.0512.405	51	115.0373.885	137
114.0301.907	60	114.0512.407	51	115.0373.888	137
114.0301.951	59	114.0512.408	51	115.0373.889	137
114.0301.961	58	114.0512.409	51	115.0373.890	137
114.0301.998	61	114.0512.410	51	115.0373.901	137
114.0302.015	61	114.0556.500	63	115.0373.928	139
114.0302.016	61	114.0556.572	63	115.0373.929	139
114.0302.018	61	114.0556.573	63	115.0373.930	139
114.0302.021	61	114.0556.574	63	115.0373.943	139
114.0302.676	52	114.0556.575	63	115.0373.944	139
114.0302.683	53	114.0556.580	65	115.0373.945	139
114.0302.693	53	114.0556.582	65	115.0391.460	146
114.0302.697	56	114.0556.583	65	115.0391.481	146
114.0302.702	57	114.0556.584	65	115.0391.482	146
114.0302.705	55	114.0556.585	65	115.0392.332	138
114.0302.708	55	114.0556.590	63	115.0392.333	138
114.0302.711	57	114.0556.592	63	115.0392.337	138
114.0302.751	72	114.0556.593	63	115.0392.340	138
114.0302.757	72	114.0556.594	63	115.0392.352	138
114.0302.760	72	114.0556.595	63	115.0392.353	138
114.0303.666	73	114.0556.600	63	115.0392.356	138
114.0303.669	73	114.0556.612	63	115.0392.357	138
114.0303.670	73	114.0556.613	63	115.0392.358	138
114.0303.671	73	114.0556.614	63	115.0392.362	138
114.0303.672	73	114.0556.615	63	115.0392.368	138
114.0316.526	71	114.0592.966	65	115.0392.369	138
114.0316.528	71	114.0593.067	65	115.0392.370	138
114.0336.417	59	114.0593.068	65	115.0392.382	138
114.0336.914	59	114.0593.070	65	115.0393.976	132
114.0336.916	59	114.0593.073	65	115.0458.915	147
114.0336.936	59	114.0593.094	64	115.0470.654	143
114.0336.938	59	114.0593.095	64	115.0470.655	143
114.0336.939	59	114.0593.096	64	115.0470.658	143
114.0368.449	80	114.0593.098	64	115.0470.659	143
114.0368.466	80	114.0593.108	47	115.0470.660	143
114.0368.467	80	114.0593.130	62	115.0470.661	143
114.0378.095	53	114.0593.141	64	115.0470.665	143
114.0378.121	53	114.0593.171	62	115.0470.666	143
114.0378.124	53	114.0593.172	62	115.0470.669	143
114.0378.125	53	114.0593.173	62	115.0470.670	143
114.0378.126	53	114.0593.175	62	115.0470.674	143
114.0463.691	81	114.0625.620	67	115.0470.675	143
114.0463.692	81	114.0625.621	67	115.0472.959	129
114.0463.694	81	114.0625.623	67	115.0472.960	129
114.0463.698	81	114.0625.624	67	115.0476.760	148
114.0463.958	80	114.0625.625	67	115.0476.822	148
114.0476.963	48	114.0625.626	67	115.0476.823	148
114.0476.964	48	114.0625.627	67	115.0476.824	148
114.0476.965	48	114.0625.629	67	115.0476.826	148
114.0476.966	48	114.0625.630	67	115.0476.827	148
114.0476.967	48	114.0625.631	67	115.0476.828	148</

KUIDAS TEHA AUK FRANKE FRAGRANITE VALAMUSSE?



- 1.** Te vajate: Teemantfreesi läbimõõduga Ø 35 mm segisti ja nupu augu puurimiseks
Art. Nr. 112.0473.656
€ 3,90

Enne valamu paigaldamist tööpinnale asetage valamu tagurpidi kindlale pinnale.

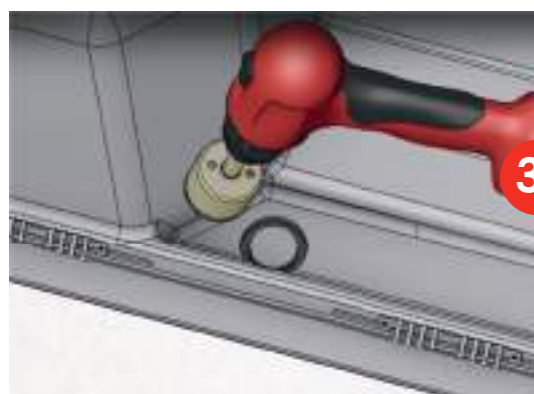

- 3.** Akutrelli otsa paigaldatud augufreesiga freesige ettefreesitud auk lõpuni.

Kui auk on puuritud, puhastage augu servad.

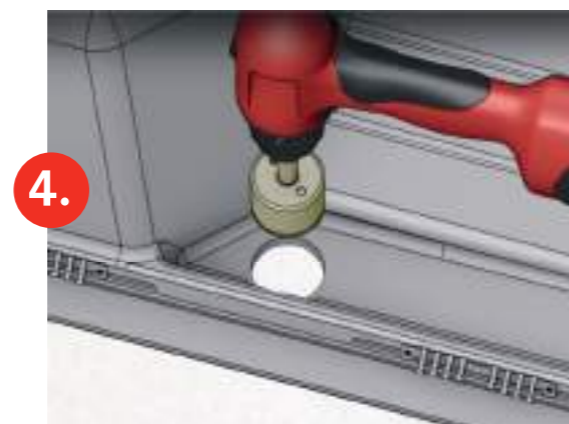

- 4.**

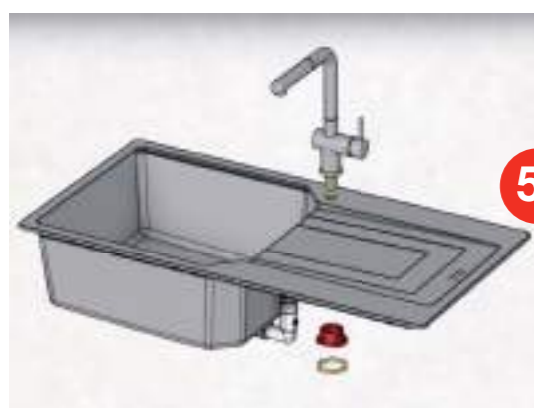

- 5.** Paigaldage segisti ja põhjasõela nupp.

Youtube
FrankeKitchenSystems



sagatavošnas datums: 2 February 2021 3:36 pm



Telli oma lend:
Tomas OLEVSONAS
Ülempiloot
Email: tomas@balloon.lt
Mob: +370 652 00 004

Ikoonide selgitused

Ühe pilguga: mida valamu võimaldab?

Piktogrammide annavad kiire ülevaate valamu tehniliste omaduste kohta.

45 cm
Aluskapi laius



Vajutusnupp: Põhjasõela avamine ja sulgemine vajutusnupuga. Vee väljavool on avatud, kui nupp on valamuga ühes tasapinnas.



Pöördnupp: põhjasõela avamine ja sulgemine pöördnupuga.



Käsitsi: käega põhjasõela kergitamise avatakse vee väljavool ja põhjasõela vajutamise sulatakse vee väljavool. Ei ole vaja teha täiendavat auku valamusse ega ka tööpinda.



Tõstenupp: põhjasõela avamine ja sulgemine tõstenupuga.



Integreeritud äravool: väljavoolu ülemine osa on pressitud valamu põhja. Nii on valamu põhi täiesti sile ilma tihenditeta, seega väga hügieeniline. Ei sobi jäätmepurustaja paigaldamiseks.



Kerge paigaldada: kiirkambritega on võimalik valamuid 1 minutiga monteerida.



Jäätmepurustaja ühendamine on võimalik

Süvistatav

Tasapinnaline

SlimTop

Altpoolt monteeritav

Ühe pilguga: mida võimaldab segisti?

Piktogrammide annavad kiire ülevaate segistite tehniliste omaduste kohta.



Kangsegisti: segistil on jäik otsik st ilma väljatõmmatava voolikuta.



Väljatõmmatava voolikuga: Segistil on väljatõmmatav voolik. Otsikul on tavaline juga.



Väljatõmmatava duššivoolikuga: Segistil on väljatõmmatav voolik. Otsikul on ümberlülitiga tavaline juga ja dušš.



Franke kuuma vee segisti



Akna ette monteeritav: ideaalne akna ette paigaldamiseks. Segistit saab akna avamisel maha painutada või mõnedel mudelitel tööpinna sisse suruda.



Pöördeulatus: näitab kui suures ulatuses on võimalik jooksutoru pöörata.



Voolikute pikkus: kaasas olevate ühendusvoolikute pikkus segisti alumisest äärest kuni ühenduskohani.



Kang mõlemal küljel: võimalik on monteerida kang paremal või vasakul.



Kang keskel: Segistil on kang üleval.



Kang paremal: Segisti saab monteerida ainult kang paremal.



FRANKE GmbH
Mumpferfährstraße 70
79713
Bad Säckingen
Deutschland
www.franke.de
www.franke.de/ks
ks-export.de@franke.com

Eesti
www.franke.ee/ks
www.facebook.com/FrankeKitchen.Baltic

FRANKE